

AC 45 City

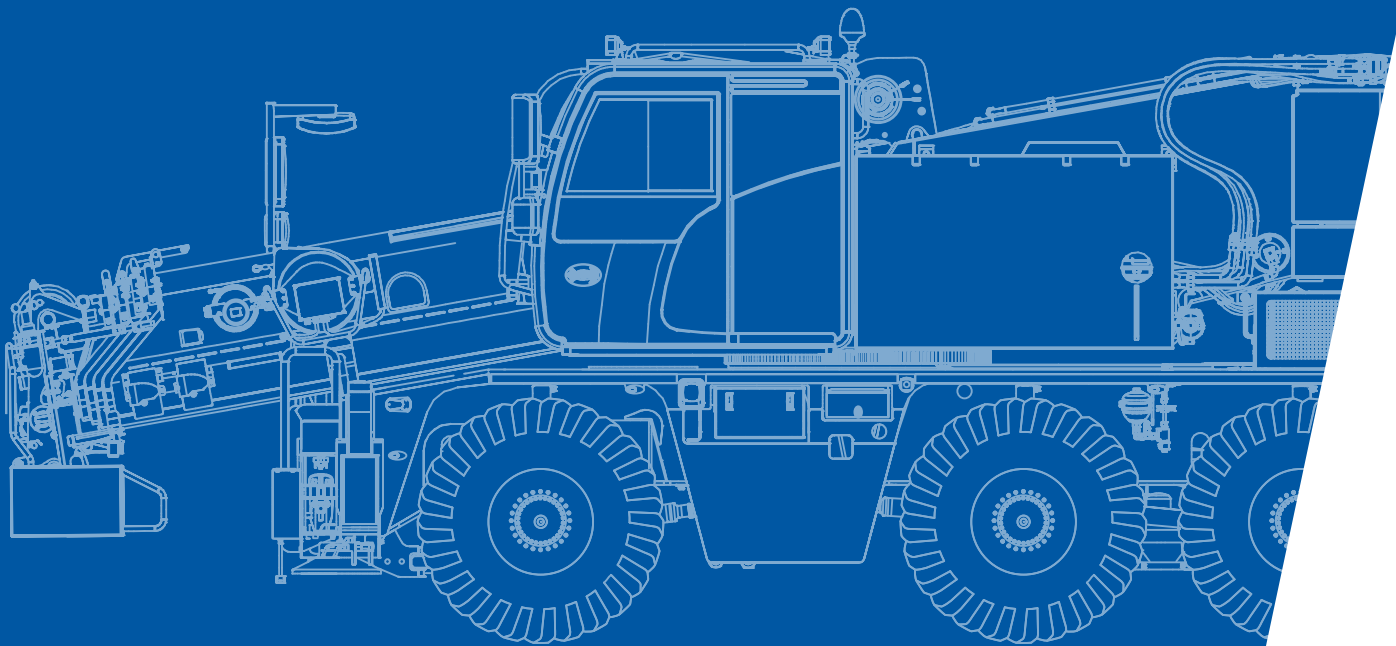

**All Terrain Crane
50 USt Capacity class**

DEMAG
BY TEREX

	Page:
Dimensions.....	4
Specifications.....	6
Equipment.....	8
Counterweight.....	9

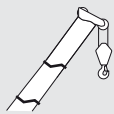

HA

Main boom.....	10
----------------	----

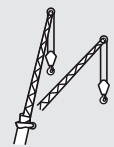

HAV

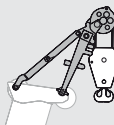

Folding swing-away jib.....	16
-----------------------------	----



MS

Runner.....	22
-------------	----

Technical description.....	34
----------------------------	----

	Counterweight		Boom telescoping
	Lifting capacities on outriggers 360°		Boom elevation
	Radius		Working speeds
	Main boom		Max. line pull
	Folding swing-away jib		Rope diameter
	Runner		Rope length
	Free on wheels		Hook block (capacity-sheaves-rope diameter)
	Max. axle loads		Number of lines
	Mechanism		Possible load of hook block
	Tires		Weight of hook block
	Hook block		Distance head sheave axle – hook ground
	Hoist		Number of sheaves in boom head
	Travel speed		Supporting force
	Gradeability – road		Length of stroke (support cylinders)
	Gradeability – off road		Payload incl. rear storage box
	Slewing		

Dimensions

AC 45 CITY

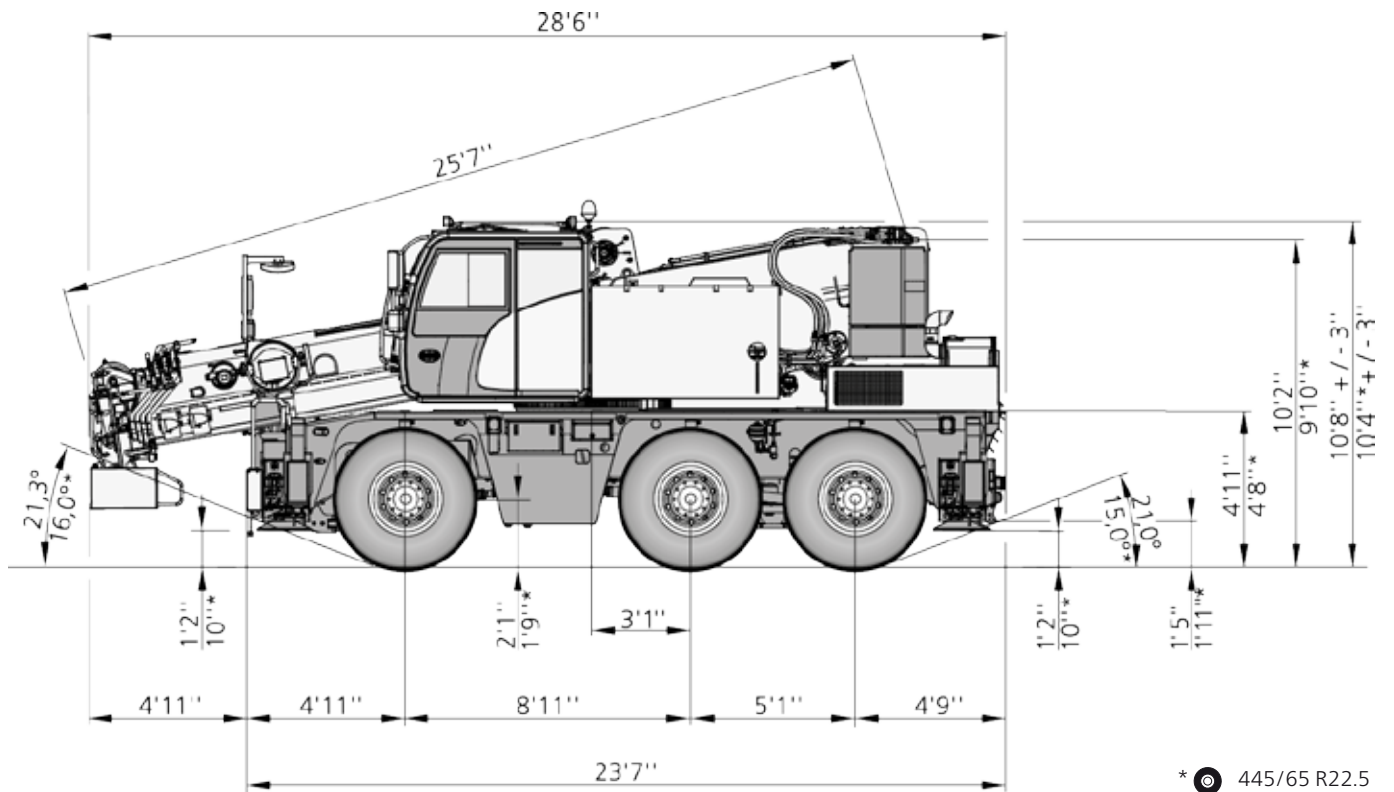

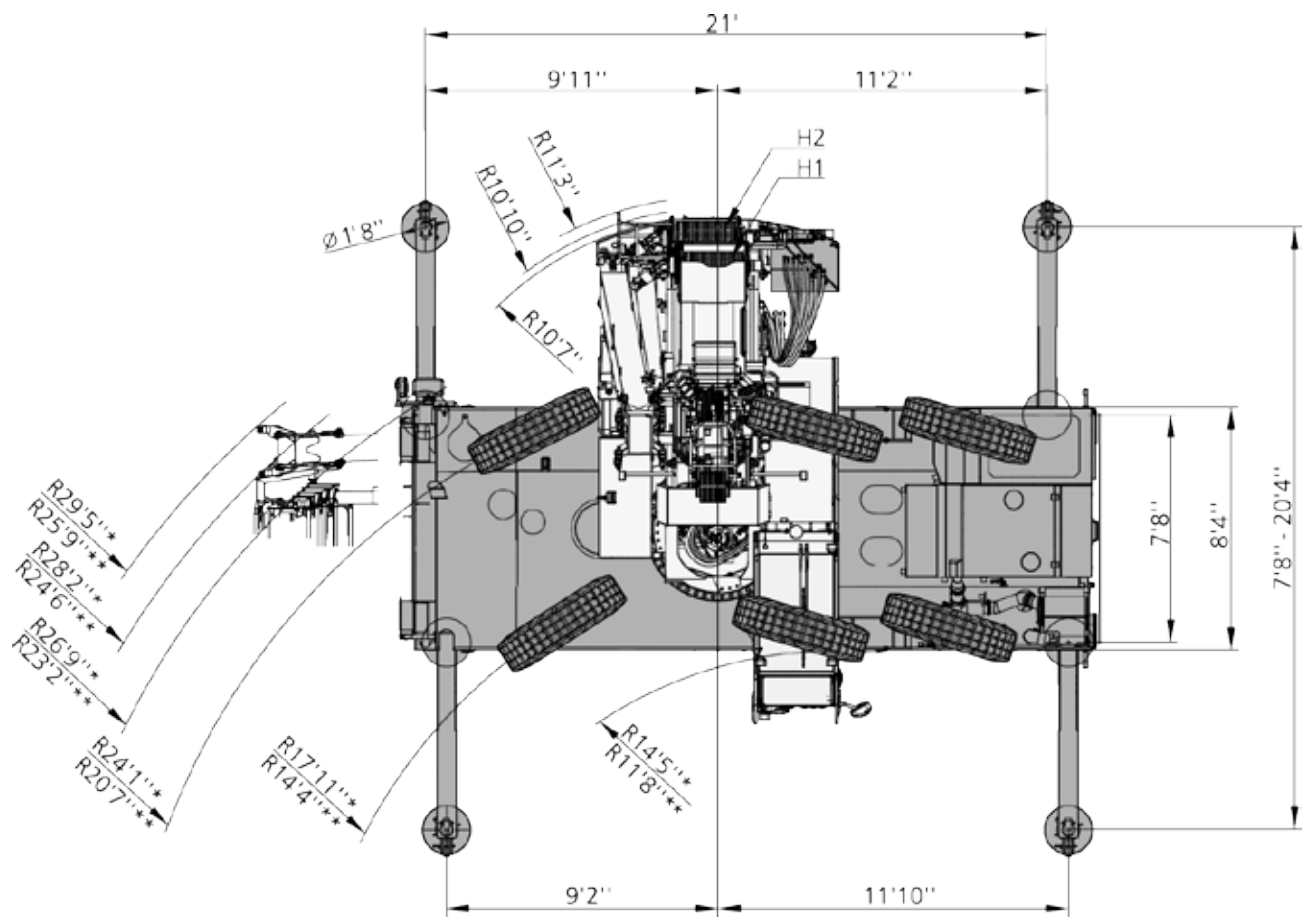









* steering mode 2



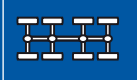

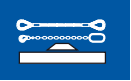

** steering mode 3

see page 6



Specifications

AC 45 CITY





										
	22,050 lb	57,300 lb	6 x 6 x 6	385/95R25	102.4 ft	-	-	-	-	-
	22,050 lb	66,100 lb	6 x 6 x 6	385/95R25	102.4 ft	32-3-16	6,400 lb	-	X	-
	26,500 lb	75,000 lb	6 x 6 x 6	385/95R25	102.4 ft	32-3-16	11,700 lb	42.7 ft	X	880 lb











	1 Highway > 28.0 mph		4* Off-wall
	2 City < 28.0 mph		5* Crab steer mode
	3* Minimum turning radius < 12.4 mph		6* Manually steered

*must be activated

	
70,560 lb	63,950 lb
19.7 ft	19.7 ft
49.7 mph ¹⁾	

¹⁾ Depending on tire type, size and country specific legislation

		
	445 / 65 R22.5 18.00 R22.5	385 / 95 R25 14.00 R25
	35 %	29 %
	> 80 %	70 %

				
	364 ft/min	9,847 lbf	0.63 in.	459 ft
	364 ft/min	9,847 lbf	0.63 in.	459 ft
	1,70 min ⁻¹			
	80 s (25.6 ft – 102.4 ft)			
	50 s (-10° - 77°)			

					
1	9,700	5-0-16	4	287 lb	2.6 ft
2	19,400	16-1-16	4	496 lb	3.6 ft
3	29,000	16-1-16	4	496 lb	3.6 ft
4	38,400	32-3-16	4	772 lb	4.3 ft
5	47,800	32-3-16	4	772 lb	4.3 ft
6	57,100	32-3-16	4	772 lb	4.3 ft
7	66,200	32-3-16	4	772 lb	4.3 ft
8	75,300	50-5-16	4	904 lb	6.2 ft
9	84,300	50-5-16	4 + 1	904 lb	6.2 ft
10	88,200	50-5-16	4 + 1	904 lb	6.2 ft

Weights and axle loads

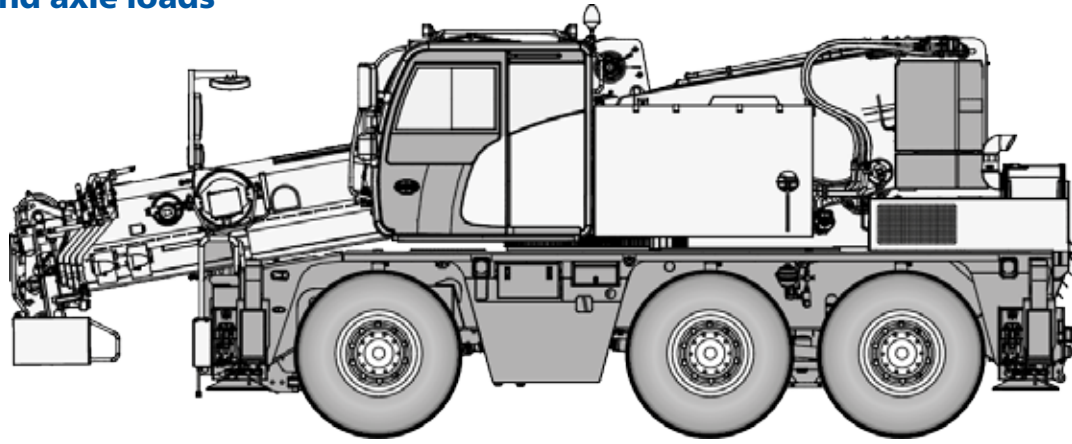

	Axle 1	Axle 2	Axle 3	Total
Basic crane (6 x 4 x 6, counterweight 11,700 lb, Michelin 445/65 R22.5 (18.00 R22.5), hook block 32-3-16-D)	18,698 lb	24,284 lb	24,364 lb	67,347 lb

Adjust gross vehicel weight / axle loads by removal, addition or substitution of options.

	Axle 1	Axle 2	Axle 3	Total	
removal	Counterweight 5,300 lb (c)	+ 1,753 lb	- 3,497 lb	- 3,461 lb	- 5,205 lb
	Counterweight 2,000 lb (b)	+ 677 lb	- 1,318 lb	- 1,305 lb	- 1,947 lb
	Counterweight 4,400 lb (a)	+ 1,402 lb	- 2,972 lb	- 2,943 lb	- 4,513 lb
	Hook block 32-3-16-D	- 1,219 lb	+ 225 lb	+ 223 lb	- 772 lb
addition	HAV 13 m	+ 1,451 lb	+ 289 lb	+ 287 lb	+ 2,026 lb
	MS (runner) at carrier tail	- 432 lb	+ 542 lb	+ 536 lb	+ 646 lb
	MS (runner) at main boom	+ 774 lb	- 150 lb	- 150 lb	+ 474 lb
	Counterweight storage	- 40 lb	+ 79 lb	+ 79 lb	+ 119 lb
	2. hoist (H2)	+ 322 lb	+ 428 lb	+ 423 lb	+ 1,173 lb
	Underride guard	- 46 lb	+ 62 lb	+ 60 lb	+ 75 lb
	CombiBox tail	- 86 lb	+ 110 lb	+ 110 lb	+ 134 lb
	CombiBox tail incl. payload	- 227 lb	+ 291 lb	+ 289 lb	+ 353 lb
	Timber storage front	+ 179 lb	- 29 lb	- 26 lb	+ 123 lb
	Timber storage front incl. timber	+ 637 lb	- 93 lb	- 90 lb	+ 454 lb
	Hook storage	+ 143 lb	- 22 lb	- 22 lb	+ 99 lb
Hook storage incl. hook block 5-0-16-E	+ 412 lb	- 62 lb	- 64 lb	+ 287 lb	
substitution	Axles 6 x 6 x 6	+ 95 lb	+ 249 lb	+ 168 lb	+ 511 lb
	Wheels 385/95R25 (14.00R25) Michelin	+ 390 lb	+ 390 lb	+ 390 lb	+ 1,171 lb
	Hook block 16-1-16-E	- 348 lb	+ 64 lb	+ 64 lb	- 220 lb
	Hook block 5-0-16-E	- 774 lb	+ 143 lb	+ 143 lb	- 487 lb

Equipment

AC 45 CITY

HAV

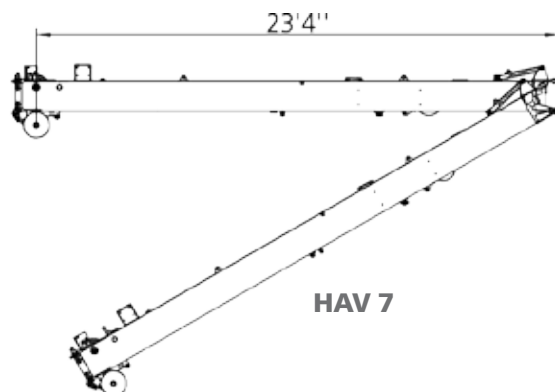
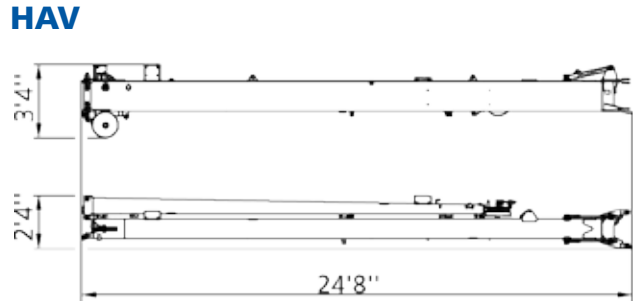

Weight: 1,210 lb

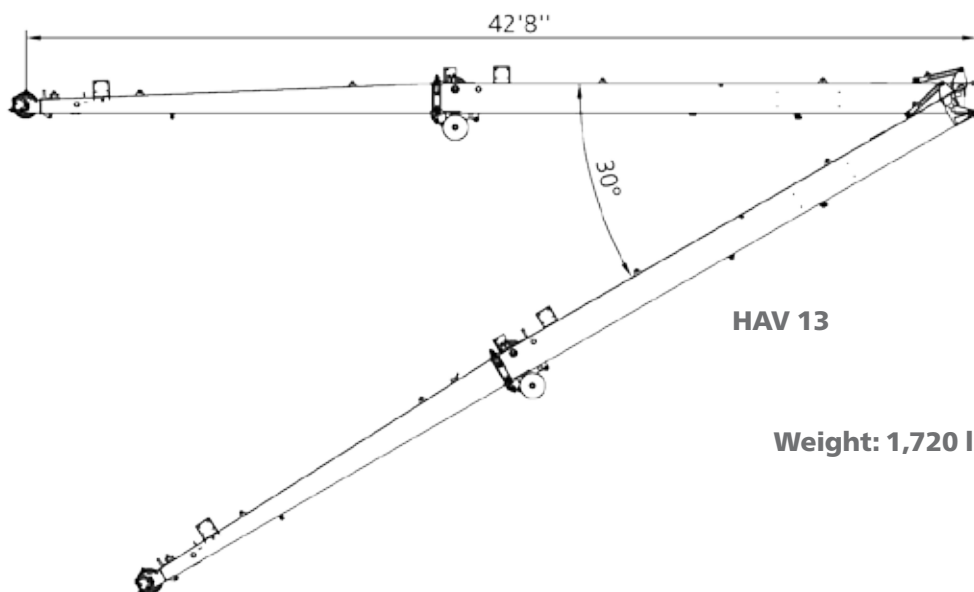

Weight: 1,720 lb

MS

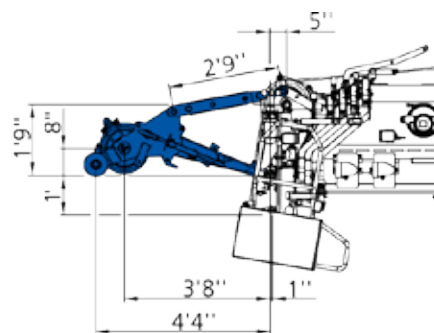
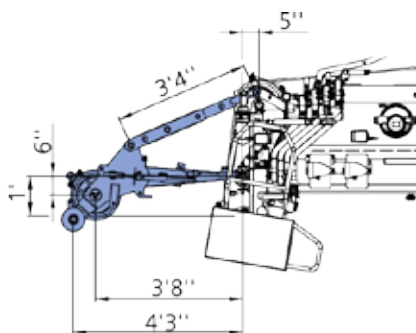
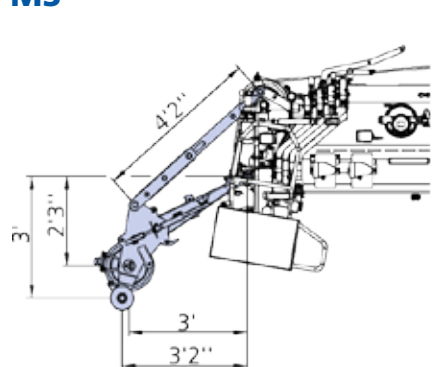

Weight: 420 lb

Counterweight

AC 45 CITY

Parts

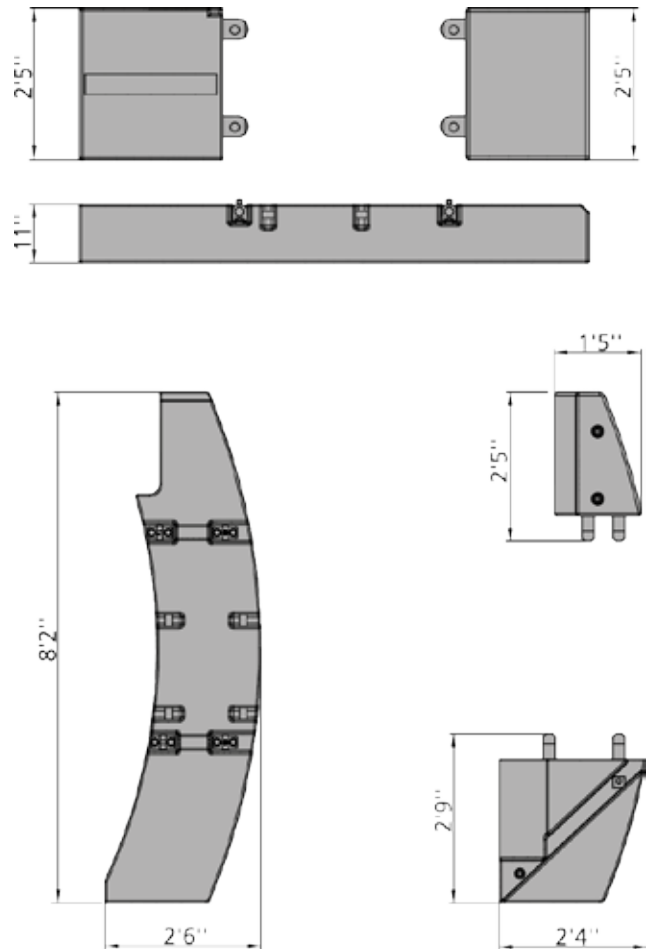
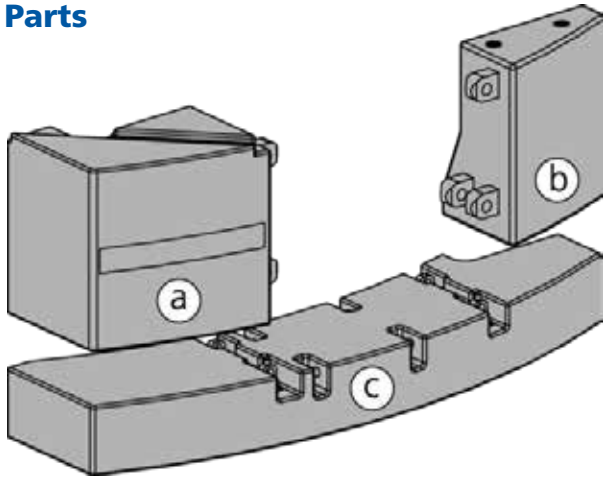

Configurations

	Ⓐ 4,400 lb	Ⓑ 2,000 lb	Ⓒ 5,300 lb
0 lb			
5,300 lb			X
6,400 lb	X	X	
11,700 lb	X	X	X

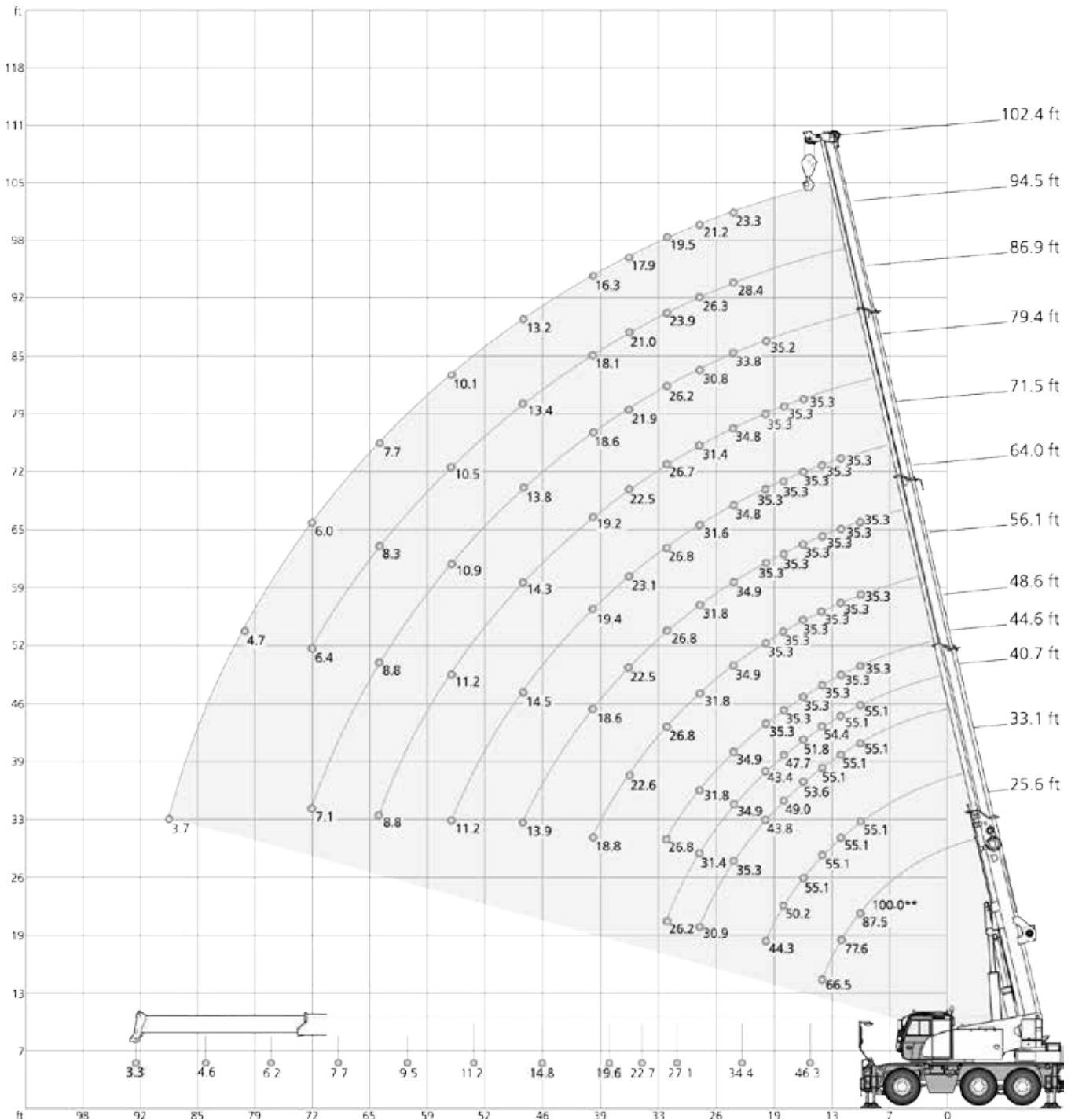

☰ 11,700 lb		🏗️ 20.3 ft x 21.0 ft											360°		85%	
↙	↘	25.6*	25.6	33.1	40.7	44.6	48.6	(ft) 56.1	64.0	71.5	79.4	86.9	94.5	102.4	↘	
ft		1,000 lb													ft	
		100.0**	-	-	-	-	-	-	-	-	-	-	-	-	-	
10		87.5	77.4	55.1	55.1	55.1	35.3	35.3	35.3	-	-	-	-	-	10	
12		77.6	71.9	55.1	55.1	55.1	35.3	35.3	35.3	35.3	-	-	-	-	12	
14		66.5	65.7	55.1	55.1	54.4	35.3	35.3	35.3	35.3	-	-	-	-	14	
16		-	-	55.1	53.6	51.8	35.3	35.3	35.3	35.3	35.3	-	-	-	16	
18		-	-	50.2	49.0	47.7	35.3	35.3	35.3	35.3	35.3	-	-	-	18	
20		-	-	44.3	43.8	43.4	35.3	35.3	35.3	35.3	35.3	35.2	-	-	20	
24		-	-	-	35.3	34.9	34.9	34.9	34.9	34.8	34.8	33.8	28.4	23.3	24	
28		-	-	-	30.9	31.4	31.8	31.8	31.8	31.6	31.4	30.8	26.3	21.2	28	
32		-	-	-	-	26.2	26.8	26.8	26.8	26.8	26.7	26.2	23.9	19.5	32	
36		-	-	-	-	-	-	22.6	22.5	23.1	22.5	21.9	21.0	17.9	36	
40		-	-	-	-	-	-	18.8	18.6	19.4	19.2	18.6	18.1	16.3	40	
48		-	-	-	-	-	-	-	13.9	14.5	14.3	13.8	13.4	13.2	48	
56		-	-	-	-	-	-	-	-	11.2	11.2	10.9	10.5	10.1	56	
64		-	-	-	-	-	-	-	-	-	8.8	8.8	8.3	7.7	64	
72		-	-	-	-	-	-	-	-	-	-	7.1	6.4	6.0	72	
80		-	-	-	-	-	-	-	-	-	-	-	-	4.7	80	
88		-	-	-	-	-	-	-	-	-	-	-	-	3.7	88	
1)		46.3	46.3	34.4	27.1	22.7	19.6	14.8	11.2	9.5	7.7	6.2	4.6	3.3	1)	

1) Capacities with horizontal boom

* 180° over front

** Capacity class

6,400 lb		20.3 ft x 21.0 ft											360°		85%	
		(ft)														
		1,000 lb														
ft		25.6	33.1	40.7	44.6	48.6	56.1	64.0	71.5	79.4	86.9	94.5	102.4	ft		
10		77.4	55.1	55.1	55.1	35.3	35.3	35.3	-	-	-	-	-	10		
12		71.7	55.1	55.1	55.1	35.3	35.3	35.3	35.3	-	-	-	-	12		
14		64.2	55.1	55.1	54.4	35.3	35.3	35.3	35.3	-	-	-	-	14		
16		-	53.5	53.1	51.8	35.3	35.3	35.3	35.3	35.3	-	-	-	16		
18		-	48.0	47.5	46.8	35.3	35.3	35.3	35.3	35.3	-	-	-	18		
20		-	42.1	41.7	41.4	35.3	35.3	35.3	35.3	35.3	35.2	-	-	20		
24		-	-	34.0	34.2	34.4	34.4	34.4	34.4	33.7	32.9	28.4	23.3	24		
28		-	-	27.9	28.8	29.3	29.3	29.3	29.3	28.8	27.2	25.9	21.2	28		
32		-	-	-	22.7	23.1	23.3	23.3	24.0	23.2	22.9	22.2	19.5	32		
36		-	-	-	-	-	19.4	19.4	20.0	19.8	19.3	18.6	17.5	36		
40		-	-	-	-	-	16.0	15.9	16.6	16.4	15.9	15.7	15.3	40		
48		-	-	-	-	-	-	11.6	12.2	12.2	12.1	11.5	11.1	48		
56		-	-	-	-	-	-	-	9.3	9.3	9.2	8.6	8.2	56		
64		-	-	-	-	-	-	-	-	7.2	7.2	6.6	6.1	64		
72		-	-	-	-	-	-	-	-	-	5.5	5.1	4.7	72		
80		-	-	-	-	-	-	-	-	-	-	-	3.4	80		
88		-	-	-	-	-	-	-	-	-	-	-	2.6	88		
1)		46.3	34.4	23.4	19.6	16.8	12.3	9.3	7.9	6.2	4.9	3.3	2.2	1)		

5,300 lb		20.3 ft x 21.0 ft											360°		85%	
		(ft)														
		1,000 lb														
ft		25.6	33.1	40.7	44.6	48.6	56.1	64.0	71.5	79.4	86.9	94.5	102.4	ft		
10		77.4	55.1	55.1	55.1	35.3	35.3	35.3	-	-	-	-	-	10		
12		71.5	55.1	55.1	55.1	35.3	35.3	35.3	35.3	-	-	-	-	12		
14		63.8	55.1	55.1	54.4	35.3	35.3	35.3	35.3	-	-	-	-	14		
16		-	53.1	52.8	51.8	35.3	35.3	35.3	35.3	35.3	-	-	-	16		
18		-	47.6	47.1	46.5	35.3	35.3	35.3	35.3	35.3	-	-	-	18		
20		-	41.9	41.2	41.0	35.3	35.3	35.3	35.3	35.3	35.2	-	-	20		
24		-	-	33.7	33.9	34.2	34.2	34.2	34.0	33.5	32.6	28.4	23.3	24		
28		-	-	27.0	27.8	28.6	28.6	28.6	28.4	27.8	26.3	25.5	21.2	28		
32		-	-	-	22.0	22.5	22.5	22.5	23.4	22.6	22.3	21.3	19.5	32		
36		-	-	-	-	-	18.6	18.6	19.4	19.3	18.6	17.9	17.2	36		
40		-	-	-	-	-	15.3	15.3	16.0	16.0	15.3	15.3	14.9	40		
48		-	-	-	-	-	-	11.1	11.7	11.7	11.5	11.1	10.6	48		
56		-	-	-	-	-	-	-	9.0	8.9	8.8	8.3	7.8	56		
64		-	-	-	-	-	-	-	-	6.9	6.8	6.3	5.7	64		
72		-	-	-	-	-	-	-	-	-	5.3	4.7	4.2	72		
80		-	-	-	-	-	-	-	-	-	-	-	3.1	80		
88		-	-	-	-	-	-	-	-	-	-	-	2.2	88		
1)		46.3	34.4	22.5	19.0	16.1	11.9	8.8	7.5	5.7	4.6	3.1	2.0	1)		

1) Capacities with horizontal boom

0 lb		20.3 ft x 21.0 ft											360°		85%	
		(ft)														
		1,000 lb														
ft		25.6	33.1	40.7	44.6	48.6	56.1	64.0	71.5	79.4	86.9	94.5	102.4	ft		
10		77.4	55.1	55.1	55.1	35.3	35.3	35.3	-	-	-	-	-	10		
12		70.8	55.1	55.1	55.1	35.3	35.3	35.3	35.3	-	-	-	-	12		
14		61.1	55.1	55.1	54.4	35.3	35.3	35.3	35.3	-	-	-	-	14		
16		-	51.3	50.8	50.3	35.3	35.3	35.3	35.3	35.3	-	-	-	16		
18		-	45.3	44.8	44.4	35.3	35.3	35.3	35.3	35.3	-	-	-	18		
20		-	39.4	38.9	38.4	35.2	35.2	35.1	35.0	34.9	34.7	-	-	20		
24		-	-	30.3	31.1	32.0	32.0	31.1	30.8	29.1	28.2	26.5	23.3	24		
28		-	-	22.4	23.3	24.0	24.0	24.0	24.7	24.1	22.6	21.3	20.5	28		
32		-	-	-	18.1	18.8	18.8	18.8	19.5	19.4	18.6	18.1	17.0	32		
36		-	-	-	-	-	15.4	15.4	16.1	16.1	15.5	15.2	14.3	36		
40		-	-	-	-	-	12.5	12.5	13.1	13.1	12.9	12.5	11.8	40		
48		-	-	-	-	-	-	8.8	9.4	9.4	9.2	8.8	8.3	48		
56		-	-	-	-	-	-	-	7.1	7.0	6.9	6.3	5.9	56		
64		-	-	-	-	-	-	-	-	5.2	5.2	4.5	4.1	64		
72		-	-	-	-	-	-	-	-	-	3.8	3.3	2.7	72		
1)		46.3	31.3	18.5	15.4	13.2	9.5	6.8	5.7	4.2	3.1	2.0	-	1)		

1) Capacities with horizontal boom

☰ 11,700 lb		📏 14.4 ft x 21.0 ft											360°		85%
📐		(ft)											📐		
📐		25.6	33.1	40.7	44.6	48.6	56.1	64.0	71.5	79.4	86.9	94.5	102.4	📐	
ft		1,000 lb											ft		
10	75.5	55.1	55.1	55.1	35.3	35.3	35.3	-	-	-	-	-	-	10	
12	66.5	55.1	55.1	55.1	35.3	35.3	35.3	35.3	-	-	-	-	-	12	
14	56.7	52.8	52.1	50.9	35.3	35.3	35.3	35.3	-	-	-	-	-	14	
16	-	43.2	42.2	41.4	35.3	35.3	35.3	35.3	35.3	-	-	-	-	16	
18	-	34.9	34.1	33.7	33.7	33.7	33.7	33.5	32.7	-	-	-	-	18	
20	-	29.5	29.9	30.6	31.2	31.2	31.2	30.9	29.7	27.8	25.5	-	-	20	
24	-	-	21.8	22.5	22.9	22.9	22.9	23.8	23.6	22.3	21.8	20.6	-	24	
28	-	-	16.8	17.3	17.7	17.9	17.7	18.4	18.4	18.3	17.6	17.0	-	28	
32	-	-	-	13.8	14.3	14.3	14.3	14.8	14.8	14.8	14.3	13.9	-	32	
36	-	-	-	-	-	12.0	12.0	12.4	12.4	12.3	12.0	11.5	-	36	
40	-	-	-	-	-	9.9	9.9	10.3	10.3	10.2	9.9	9.5	-	40	
48	-	-	-	-	-	-	7.2	7.7	7.6	7.6	7.2	6.8	-	48	
56	-	-	-	-	-	-	-	5.9	5.8	5.7	5.4	5.0	-	56	
64	-	-	-	-	-	-	-	-	4.5	4.4	4.0	3.7	-	64	
72	-	-	-	-	-	-	-	-	-	3.5	3.1	2.9	-	72	
80	-	-	-	-	-	-	-	-	-	-	-	1.9	-	80	
1)	44.5	22.5	14.1	11.9	10.4	7.7	5.7	4.9	3.7	3.1	2.0	-	-	1)	

☰ 11,700 lb		📏 7.7 ft x 21.0 ft											360°		85%
📐		(ft)											📐		
📐		25.6	33.1	40.7	44.6	48.6	56.1	64.0	71.5	79.4	86.9	94.5	102.4	📐	
ft		1,000 lb											ft		
16	-	19.1	19.4	20.0	20.7	20.7	20.5	20.7	19.7	-	-	-	-	16	
18	-	16.0	16.3	16.9	17.5	17.5	17.5	17.8	17.4	-	-	-	-	18	
20	-	13.4	13.6	14.2	14.7	14.7	14.7	15.1	15.1	14.9	13.9	-	-	20	
24	-	-	10.1	10.5	11.0	11.0	11.0	11.7	11.4	11.4	11.0	10.2	-	24	
28	-	-	7.8	8.2	8.7	8.7	8.7	9.2	9.0	9.0	8.5	8.2	-	28	
32	-	-	-	6.5	6.9	6.9	6.9	7.4	7.2	7.2	6.9	6.5	-	32	
36	-	-	-	-	-	5.6	5.6	6.1	6.0	6.0	5.6	5.3	-	36	
40	-	-	-	-	-	4.5	4.5	4.9	4.9	4.9	4.5	4.3	-	40	
48	-	-	-	-	-	-	3.2	3.5	3.5	3.5	3.0	2.8	-	48	
56	-	-	-	-	-	-	-	2.5	2.5	2.4	2.1	1.7	-	56	
64	-	-	-	-	-	-	-	-	1.7	1.7	-	-	-	64	
1)	-	10.4	6.6	5.5	4.9	3.3	2.4	2.0	1.3	-	-	-	-	1)	

1) Capacities with horizontal boom

11,700 lb		0° *		85%	
		(ft)			
		25.6	33.1	40.7	44.6
ft	1,000 lb				
10	52.8	52.0	46.2	43.4	
12	44.1	41.1	36.6	34.6	
14	32.7	31.6	29.8	28.3	
16	-	24.4	23.7	23.2	
18	-	20.0	19.4	19.2	
20	-	16.4	15.7	15.5	
24	-	-	11.3	11.0	
28	-	-	8.4	8.0	
32	-	-	-	6.1	
1)	25.6	12.3	6.8	4.9	

11,700 lb		180° **		85%	
		(ft)			
		25.6	33.1	40.7	44.6
ft	1,000 lb				
10	26.2	25.7	25.5	25.1	
12	22.5	22.1	21.7	21.4	
14	19.3	19.1	18.7	18.3	
16	-	16.6	16.3	15.9	
18	-	14.6	14.4	13.9	
20	-	12.8	12.6	12.1	
24	-	-	9.7	9.5	
28	-	-	7.6	7.3	
32	-	-	-	5.8	
1)	16.8	10.4	6.4	4.9	

11,700 lb		360°		85%	
		(ft)			
		25.6	33.1	40.7	44.6
ft	1,000 lb				
12	-	17.7	17.2	17.0	
14	15.1	14.7	14.3	14.0	
16	-	12.3	11.9	11.7	
18	-	10.5	10.2	9.9	
20	-	8.8	8.6	8.2	
24	-	-	6.1	5.8	
28	-	-	4.4	4.0	
32	-	-	-	2.7	
1)	12.6	6.6	3.1	2.0	

1) Capacities with horizontal boom

* over rear

** over front

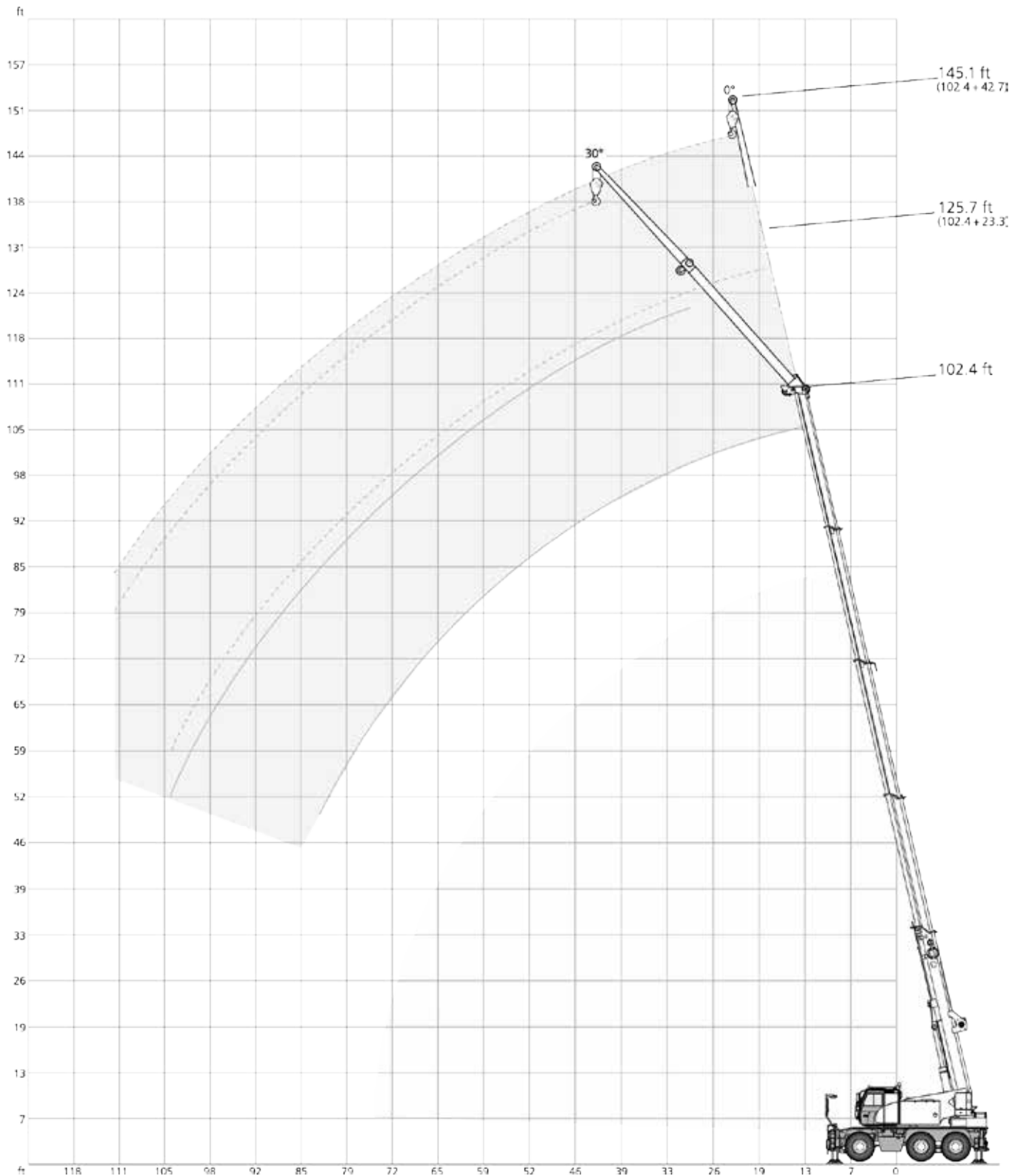
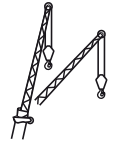

11,700 lb		20.3 ft x 21.0 ft					360°					85%	
23.3 ft													
		0°					30°						
ft	1,000 lb											ft	
10	18.2	19.4	-	-	-	-	-	-	-	-	-	-	10
12	16.6	19.4	-	-	-	-	-	-	-	-	-	-	12
14	15.4	18.8	-	-	-	-	-	-	-	-	-	-	14
16	14.3	17.6	-	-	-	-	11.4	-	-	-	-	-	16
18	13.5	16.7	18.1	-	-	-	10.9	-	-	-	-	-	18
20	12.7	15.7	17.3	-	-	-	10.5	10.5	-	-	-	-	20
24	11.2	14.2	15.7	16.0	-	-	9.8	10.0	-	-	-	-	24
28	10.1	13.0	14.5	15.0	-	-	9.2	9.6	9.7	-	-	-	28
32	9.2	11.9	13.4	14.1	13.6	-	8.9	9.3	9.3	-	-	-	32
36	-	10.9	12.6	13.2	12.9	12.0	-	8.9	9.0	9.0	-	-	36
40	-	10.1	11.8	12.5	12.3	11.4	-	8.6	8.8	8.8	8.8	8.6	40
48	-	9.0	10.5	11.2	11.2	10.3	-	8.4	8.3	8.5	8.3	7.9	48
56	-	-	9.3	10.0	10.0	9.2	-	-	8.0	8.0	8.0	7.3	56
64	-	-	8.5	9.0	8.2	8.0	-	-	7.9	7.8	7.8	6.9	64
72	-	-	7.3	7.3	6.9	6.2	-	-	-	7.5	6.9	6.4	72
80	-	-	-	6.0	5.3	4.9	-	-	-	-	5.7	5.3	80
88	-	-	-	4.9	4.3	3.8	-	-	-	-	4.5	4.3	88
96	-	-	-	-	3.3	2.9	-	-	-	-	3.6	3.2	96
104	-	-	-	-	2.5	2.1	-	-	-	-	-	2.3	104

42.7 ft													
		0°					30°						
ft	1,000 lb											ft	
10	13.6	-	-	-	-	-	-	-	-	-	-	-	10
12	12.5	-	-	-	-	-	-	-	-	-	-	-	12
14	11.6	-	-	-	-	-	-	-	-	-	-	-	14
16	10.7	12.5	-	-	-	-	-	-	-	-	-	-	16
18	10.0	11.8	-	-	-	-	-	-	-	-	-	-	18
20	9.4	11.2	12.0	-	-	-	-	-	-	-	-	-	20
24	8.3	10.1	11.0	-	-	-	-	-	-	-	-	-	24
28	7.4	9.0	10.0	10.2	-	-	-	-	-	-	-	-	28
32	6.7	8.1	9.2	9.6	-	-	6.5	-	-	-	-	-	32
36	6.2	7.5	8.5	8.9	8.8	-	6.1	6.5	-	-	-	-	36
40	5.6	7.0	7.9	8.3	8.3	8.1	5.7	6.1	6.4	-	-	-	40
48	4.7	6.0	6.8	7.3	7.5	7.5	5.2	5.6	5.9	6.0	-	-	48
56	-	5.3	6.0	6.6	6.8	6.8	-	5.2	5.5	5.6	5.6	-	56
64	-	4.7	5.4	6.1	6.3	6.3	-	4.9	5.1	5.3	5.3	5.3	64
72	-	4.2	4.9	5.3	5.7	5.7	-	4.9	4.9	5.1	5.1	5.1	72
80	-	-	4.5	5.0	5.2	5.3	-	-	4.6	4.8	4.9	4.8	80
88	-	-	4.1	4.5	4.6	4.1	-	-	-	4.6	4.8	4.5	88
96	-	-	-	4.3	3.8	3.2	-	-	-	4.5	4.1	4.0	96
104	-	-	-	3.6	3.0	2.5	-	-	-	-	3.4	3.0	104
112	-	-	-	-	2.2	2.0	-	-	-	-	-	2.4	112
120	-	-	-	-	1.9	-	-	-	-	-	-	-	120

6,400 lb		20.3 ft x 21.0 ft					360°					85%	
23.3 ft													
		0°					30°						
ft	1,000 lb											ft	
10	18.2	19.4	-	-	-	-	-	-	-	-	-	-	10
12	16.6	19.4	-	-	-	-	-	-	-	-	-	-	12
14	15.4	18.8	-	-	-	-	-	-	-	-	-	-	14
16	14.3	17.6	-	-	-	-	11.4	-	-	-	-	-	16
18	13.5	16.7	18.1	-	-	-	10.9	-	-	-	-	-	18
20	12.7	15.7	17.3	-	-	-	10.5	10.5	-	-	-	-	20
24	11.2	14.2	15.7	16.0	-	-	9.8	10.0	-	-	-	-	24
28	10.1	13.0	14.5	15.0	-	-	9.2	9.6	9.7	-	-	-	28
32	9.2	11.9	13.4	14.1	13.6	-	8.9	9.3	9.3	-	-	-	32
36	-	10.9	12.6	13.2	12.9	12.0	-	8.9	9.0	9.0	-	-	36
40	-	10.1	11.8	12.5	12.3	11.4	-	8.6	8.8	8.8	8.8	8.6	40
48	-	9.0	10.5	11.0	10.9	10.3	-	8.4	8.3	8.5	8.3	7.9	48
56	-	-	9.1	9.4	8.8	8.6	-	-	8.0	8.0	8.0	7.3	56
64	-	-	7.4	7.7	7.0	6.6	-	-	7.4	7.8	7.1	6.9	64
72	-	-	5.8	6.0	5.3	4.9	-	-	-	6.4	5.8	5.5	72
80	-	-	-	4.7	4.0	3.6	-	-	-	-	4.5	4.0	80
88	-	-	-	3.7	3.0	2.6	-	-	-	-	3.4	2.9	88
96	-	-	-	-	2.2	1.8	-	-	-	-	2.4	2.0	96
104	-	-	-	-	1.6	-	-	-	-	-	-	-	104

42.7 ft													
		0°					30°						
ft	1,000 lb											ft	
10	13.6	-	-	-	-	-	-	-	-	-	-	-	10
12	12.5	-	-	-	-	-	-	-	-	-	-	-	12
14	11.6	-	-	-	-	-	-	-	-	-	-	-	14
16	10.7	12.5	-	-	-	-	-	-	-	-	-	-	16
18	10.0	11.8	-	-	-	-	-	-	-	-	-	-	18
20	9.4	11.2	12.0	-	-	-	-	-	-	-	-	-	20
24	8.3	10.1	11.0	-	-	-	-	-	-	-	-	-	24
28	7.4	9.0	10.0	10.2	-	-	-	-	-	-	-	-	28
32	6.7	8.1	9.2	9.6	-	-	6.5	-	-	-	-	-	32
36	6.2	7.5	8.5	8.9	8.8	-	6.1	6.5	-	-	-	-	36
40	5.6	7.0	7.9	8.3	8.3	8.1	5.7	6.1	6.4	-	-	-	40
48	4.7	6.0	6.8	7.3	7.5	7.5	5.2	5.6	5.9	6.0	-	-	48
56	-	5.3	6.0	6.6	6.8	6.8	-	5.2	5.5	5.6	5.6	-	56
64	-	4.7	5.4	6.1	6.3	6.3	-	4.9	5.1	5.3	5.3	5.3	64
72	-	4.2	4.9	5.3	5.7	5.1	-	4.9	4.9	5.1	5.1	5.1	72
80	-	-	4.5	4.8	4.5	4.0	-	-	4.6	4.8	4.8	4.7	80
88	-	-	4.0	4.1	3.5	3.0	-	-	-	4.4	4.3	3.8	88
96	-	-	-	3.3	2.7	2.2	-	-	-	3.6	3.2	2.9	96
104	-	-	-	2.5	1.9	1.4	-	-	-	-	2.3	2.1	104

5,300 lb		20.3 ft x 21.0 ft					360°					85%	
23.3 ft													
		0°					30°						
ft	1,000 lb											ft	
10	18.2	19.4	-	-	-	-	-	-	-	-	-	-	10
12	16.6	19.4	-	-	-	-	-	-	-	-	-	-	12
14	15.4	18.8	-	-	-	-	-	-	-	-	-	-	14
16	14.3	17.6	-	-	-	-	11.4	-	-	-	-	-	16
18	13.5	16.7	18.1	-	-	-	10.9	-	-	-	-	-	18
20	12.7	15.7	17.3	-	-	-	10.5	10.5	-	-	-	-	20
24	11.2	14.2	15.7	16.0	-	-	9.8	10.0	-	-	-	-	24
28	10.1	13.0	14.5	15.0	-	-	9.2	9.6	9.7	-	-	-	28
32	9.2	11.9	13.4	14.1	13.6	-	8.9	9.3	9.3	-	-	-	32
36	-	10.9	12.6	13.2	12.9	12.0	-	8.9	9.0	9.0	-	-	36
40	-	10.1	11.8	12.5	12.3	11.4	-	8.6	8.8	8.8	8.8	8.6	40
48	-	9.0	10.3	10.8	10.8	10.2	-	8.4	8.3	8.5	8.3	7.9	48
56	-	-	9.0	9.2	8.5	8.2	-	-	8.0	8.0	8.0	7.3	56
64	-	-	7.2	7.2	6.6	6.1	-	-	7.3	7.4	6.9	6.6	64
72	-	-	5.5	5.5	4.9	4.4	-	-	-	6.0	5.5	5.1	72
80	-	-	-	4.5	3.8	3.4	-	-	-	-	4.2	3.8	80
88	-	-	-	3.5	2.8	2.4	-	-	-	-	3.2	2.7	88
96	-	-	-	-	2.0	1.6	-	-	-	-	2.2	1.8	96
104	-	-	-	-	1.4	-	-	-	-	-	-	-	104

42.7 ft													
		0°					30°						
ft	1,000 lb											ft	
10	13.6	-	-	-	-	-	-	-	-	-	-	-	10
12	12.5	-	-	-	-	-	-	-	-	-	-	-	12
14	11.6	-	-	-	-	-	-	-	-	-	-	-	14
16	10.7	12.5	-	-	-	-	-	-	-	-	-	-	16
18	10.0	11.8	-	-	-	-	-	-	-	-	-	-	18
20	9.4	11.2	12.0	-	-	-	-	-	-	-	-	-	20
24	8.3	10.1	11.0	-	-	-	-	-	-	-	-	-	24
28	7.4	9.0	10.0	10.2	-	-	-	-	-	-	-	-	28
32	6.7	8.1	9.2	9.6	-	-	6.5	-	-	-	-	-	32
36	6.2	7.5	8.5	8.9	8.8	-	6.1	6.5	-	-	-	-	36
40	5.6	7.0	7.9	8.3	8.3	8.1	5.7	6.1	6.4	-	-	-	40
48	4.7	6.0	6.8	7.3	7.5	7.5	5.2	5.6	5.9	6.0	-	-	48
56	-	5.3	6.0	6.6	6.8	6.8	-	5.2	5.5	5.6	5.6	-	56
64	-	4.7	5.4	6.1	6.3	6.3	-	4.9	5.1	5.3	5.3	5.3	64
72	-	4.2	4.9	5.3	5.3	4.9	-	4.9	4.9	5.1	5.1	5.1	72
80	-	-	4.5	4.7	4.2	3.8	-	-	4.6	4.8	4.8	4.7	80
88	-	-	3.9	3.9	3.3	2.7	-	-	-	4.4	4.0	3.6	88
96	-	-	-	3.1	2.4	1.9	-	-	-	3.6	3.0	2.7	96
104	-	-	-	2.5	1.8	-	-	-	-	-	2.3	1.9	104

0 lb		20.3 ft x 21.0 ft						360°						85%	
 23.3 ft															
		25.6 ft						25.6 ft							
		44.6 ft						44.6 ft							
		64.0 ft						64.0 ft							
		79.4 ft						79.4 ft							
		94.5 ft						94.5 ft							
		102.4 ft						102.4 ft							
		0°						30°							
ft	1,000 lb												ft		
10	18.2	19.4	-	-	-	-	-	-	-	-	-	-	-	10	
12	16.6	19.4	-	-	-	-	-	-	-	-	-	-	-	12	
14	15.4	18.8	-	-	-	-	-	-	-	-	-	-	-	14	
16	14.3	17.6	-	-	-	-	11.4	-	-	-	-	-	-	16	
18	13.5	16.7	18.1	-	-	-	10.9	-	-	-	-	-	-	18	
20	12.7	15.7	17.3	-	-	-	10.5	10.5	-	-	-	-	-	20	
24	11.2	14.2	15.7	16.0	-	-	9.8	10.0	-	-	-	-	-	24	
28	10.1	13.0	14.5	15.0	-	-	9.2	9.6	9.7	-	-	-	-	28	
32	9.2	11.9	13.4	14.1	13.6	-	8.9	9.3	9.3	-	-	-	-	32	
36	-	10.9	12.6	13.1	12.8	12.0	-	8.9	9.0	9.0	-	-	-	36	
40	-	10.1	11.7	12.1	11.9	11.2	-	8.6	8.8	8.8	8.8	8.8	8.6	40	
48	-	8.8	9.8	9.9	9.2	8.4	-	8.3	8.3	8.4	8.3	8.3	7.9	48	
56	-	-	7.3	7.4	6.8	6.2	-	-	7.6	7.7	7.2	6.9	56		
64	-	-	5.5	5.6	5.0	4.5	-	-	5.9	6.1	5.7	5.2	64		
72	-	-	4.0	4.2	3.6	3.1	-	-	-	4.7	4.0	3.8	72		
80	-	-	-	3.2	2.5	2.1	-	-	-	-	2.9	2.5	80		
88	-	-	-	2.4	-	-	-	-	-	-	1.9	-	88		

 42.7 ft															
		25.6 ft						25.6 ft							
		44.6 ft						44.6 ft							
		64.0 ft						64.0 ft							
		79.4 ft						79.4 ft							
		94.5 ft						94.5 ft							
		102.4 ft						102.4 ft							
		0°						30°							
ft	1,000 lb												ft		
10	13.6	-	-	-	-	-	-	-	-	-	-	-	-	10	
12	12.5	-	-	-	-	-	-	-	-	-	-	-	-	12	
14	11.6	-	-	-	-	-	-	-	-	-	-	-	-	14	
16	10.7	12.5	-	-	-	-	-	-	-	-	-	-	-	16	
18	10.0	11.8	-	-	-	-	-	-	-	-	-	-	-	18	
20	9.4	11.2	12.0	-	-	-	-	-	-	-	-	-	-	20	
24	8.3	10.1	11.0	-	-	-	-	-	-	-	-	-	-	24	
28	7.4	9.0	10.0	10.2	-	-	-	-	-	-	-	-	-	28	
32	6.7	8.1	9.2	9.6	-	-	6.5	-	-	-	-	-	-	32	
36	6.2	7.5	8.5	8.9	8.8	-	6.1	6.5	-	-	-	-	-	36	
40	5.6	7.0	7.9	8.3	8.3	8.1	5.7	6.1	6.4	-	-	-	-	40	
48	4.7	6.0	6.8	7.3	7.5	7.5	5.2	5.6	5.9	6.0	-	-	-	48	
56	-	5.3	6.0	6.6	6.7	6.2	-	5.2	5.5	5.6	5.6	-	-	56	
64	-	4.7	5.4	5.8	5.4	4.7	-	4.9	5.1	5.3	5.3	5.3	-	64	
72	-	4.2	4.6	4.7	4.0	3.3	-	4.9	4.9	5.1	5.1	4.6	-	72	
80	-	-	3.6	3.6	2.9	2.3	-	-	-	4.2	4.2	3.8	3.5	80	
88	-	-	2.8	2.7	2.0	-	-	-	-	3.3	2.8	2.4	-	88	
96	-	-	-	2.0	-	-	-	-	-	2.4	2.0	1.6	-	96	
104	-	-	-	1.4	-	-	-	-	-	-	-	-	-	104	

11,700 lb		14.4 ft x 21.0 ft					360°					85%		
23.3 ft														
		0°					30°							
ft	1,000 lb						ft							ft
10	18.2	19.4	-	-	-	-	-	-	-	-	-	-	-	10
12	16.6	19.4	-	-	-	-	-	-	-	-	-	-	-	12
14	15.4	18.8	-	-	-	-	-	-	-	-	-	-	-	14
16	14.3	17.6	-	-	-	-	11.4	-	-	-	-	-	-	16
18	13.5	16.7	18.1	-	-	-	10.9	-	-	-	-	-	-	18
20	12.7	15.7	17.3	-	-	-	10.5	10.5	-	-	-	-	-	20
24	11.2	14.2	15.7	16.0	-	-	9.8	10.0	-	-	-	-	-	24
28	10.1	13.0	14.5	15.0	-	-	9.2	9.6	9.7	-	-	-	-	28
32	9.2	11.9	13.4	13.9	13.6	-	8.9	9.3	9.3	-	-	-	-	32
36	-	10.8	11.9	12.2	11.8	11.4	-	8.9	9.0	9.0	-	-	-	36
40	-	10.0	10.6	10.8	10.1	9.9	-	8.6	8.8	8.8	8.8	8.6	8.6	40
48	-	8.0	7.8	8.0	7.4	7.2	-	8.0	8.0	8.0	7.8	7.7	7.7	48
56	-	-	5.9	6.1	5.6	5.2	-	-	6.3	6.6	6.1	5.9	5.9	56
64	-	-	4.6	4.7	4.2	4.0	-	-	4.9	5.1	4.7	4.5	4.5	64
72	-	-	3.6	3.8	3.3	2.9	-	-	-	4.0	3.6	3.3	3.3	72
80	-	-	-	3.0	2.5	2.1	-	-	-	-	2.7	2.5	2.5	80
88	-	-	-	2.2	1.7	-	-	-	-	-	1.9	-	-	88

42.7 ft														
		0°					30°							
ft	1,000 lb						ft							ft
10	13.6	-	-	-	-	-	-	-	-	-	-	-	-	10
12	12.5	-	-	-	-	-	-	-	-	-	-	-	-	12
14	11.6	-	-	-	-	-	-	-	-	-	-	-	-	14
16	10.7	12.5	-	-	-	-	-	-	-	-	-	-	-	16
18	10.0	11.8	-	-	-	-	-	-	-	-	-	-	-	18
20	9.4	11.2	12.0	-	-	-	-	-	-	-	-	-	-	20
24	8.3	10.1	11.0	-	-	-	-	-	-	-	-	-	-	24
28	7.4	9.0	10.0	10.2	-	-	-	-	-	-	-	-	-	28
32	6.7	8.1	9.2	9.6	-	-	6.5	-	-	-	-	-	-	32
36	6.2	7.5	8.5	8.9	8.8	-	6.1	6.5	-	-	-	-	-	36
40	5.6	7.0	7.9	8.3	8.3	8.1	5.7	6.1	6.4	-	-	-	-	40
48	4.7	6.0	6.8	7.3	7.3	7.2	5.2	5.6	5.9	6.0	-	-	-	48
56	-	5.3	6.0	6.2	5.9	5.5	-	5.2	5.5	5.6	5.6	-	-	56
64	-	4.7	5.1	4.9	4.5	4.2	-	4.9	5.1	5.3	5.2	5.0	5.0	64
72	-	4.2	4.0	4.0	3.5	3.1	-	4.6	4.4	4.6	4.2	4.0	4.0	72
80	-	-	3.2	3.2	2.7	2.3	-	-	3.6	3.6	3.4	3.2	3.2	80
88	-	-	2.6	2.5	2.0	1.6	-	-	-	2.9	2.6	2.4	2.4	88
96	-	-	-	1.9	-	-	-	-	-	2.2	1.9	1.7	1.7	96
104	-	-	-	1.6	-	-	-	-	-	-	-	-	-	104

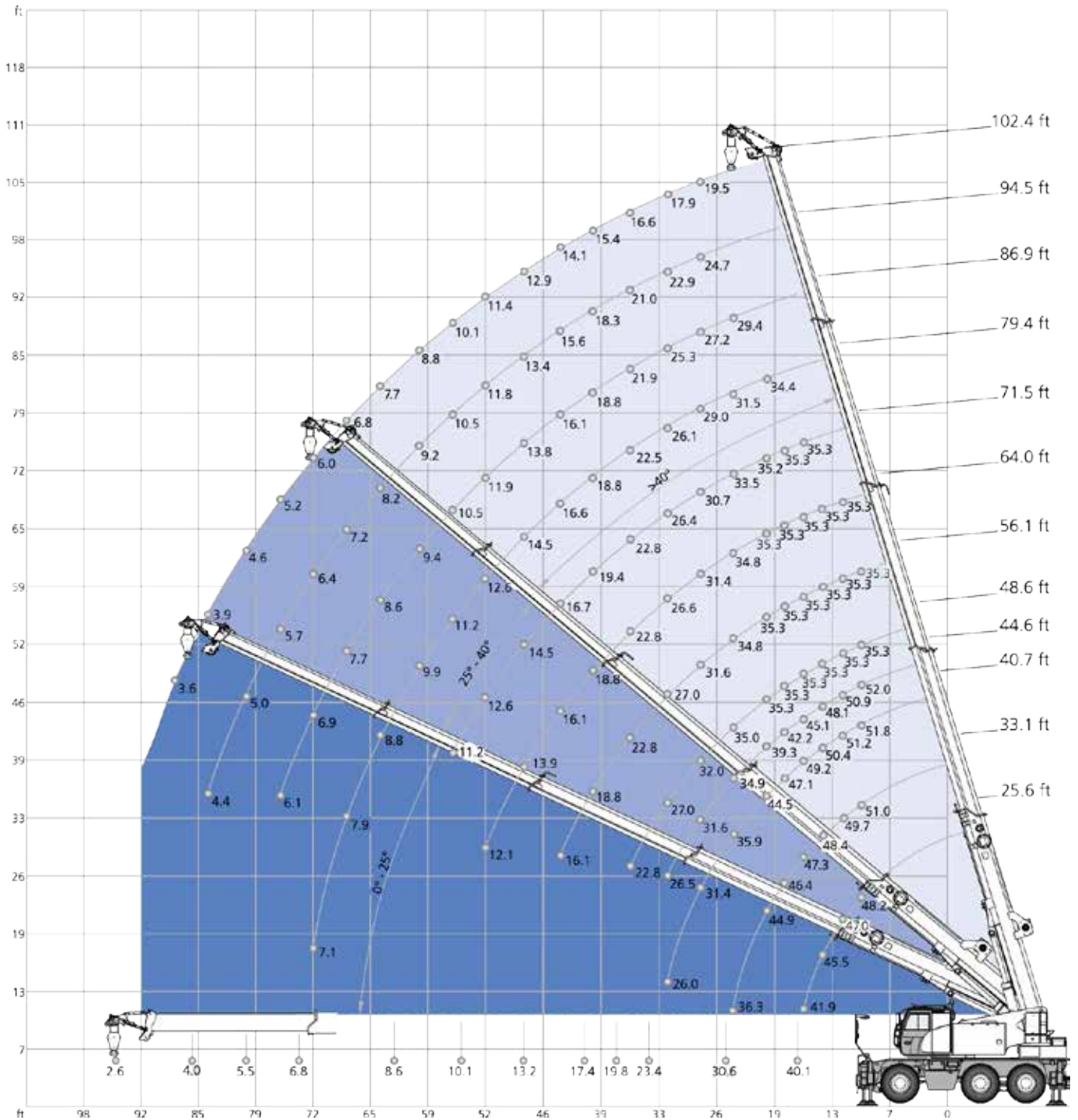
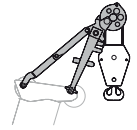

☰ 11,700 lb		🏗️ 20.3 ft x 21.0 ft					🏗️ 35,5°		360°			85%		
🏗️	🏗️	25.6	33.1	40.7	44.6	48.6	(ft)		71.5	79.4	86.9	94.5	102.4	🏗️
ft		1,000 lb											ft	
10		48.2	51.0	51.8	52.0	35.3	35.3	-	-	-	-	-	-	10
12		47.0	49.7	51.2	50.9	35.3	35.3	35.3	-	-	-	-	-	12
14		45.5	48.4	50.4	48.1	35.3	35.3	35.3	-	-	-	-	-	14
16		41.9	47.3	49.2	45.1	35.3	35.3	35.3	35.3	-	-	-	-	16
18		-	46.4	47.1	42.2	35.3	35.3	35.3	35.3	-	-	-	-	18
20		-	44.9	44.5	39.3	35.3	35.3	35.3	35.2	34.4	-	-	-	20
24		-	36.3	35.9	34.9	35.0	34.8	34.8	33.5	31.5	29.4	-	-	24
28		-	-	31.4	31.6	32.0	31.6	31.4	30.7	29.0	27.2	24.7	19.5	28
32		-	-	26.0	26.5	27.0	27.0	26.6	26.4	26.1	25.3	22.9	17.9	32
36		-	-	-	-	22.8	22.8	22.8	22.8	22.5	21.9	21.0	16.6	36
40		-	-	-	-	-	18.8	18.8	19.4	18.8	18.8	18.3	15.4	40
44		-	-	-	-	-	16.1	16.1	16.7	16.6	16.1	15.6	14.1	44
48		-	-	-	-	-	-	13.9	14.5	14.5	13.8	13.4	12.9	48
52		-	-	-	-	-	-	12.1	12.6	12.6	11.9	11.8	11.4	52
56		-	-	-	-	-	-	-	11.2	11.2	10.5	10.5	10.1	56
60		-	-	-	-	-	-	-	-	9.9	9.4	9.2	8.8	60
64		-	-	-	-	-	-	-	-	8.8	8.6	8.2	7.7	64
68		-	-	-	-	-	-	-	-	7.9	7.7	7.2	6.8	68
72		-	-	-	-	-	-	-	-	7.1	6.9	6.4	6.0	72
76		-	-	-	-	-	-	-	-	-	6.1	5.7	5.2	76
80		-	-	-	-	-	-	-	-	-	-	5.0	4.6	80
84		-	-	-	-	-	-	-	-	-	-	4.4	3.9	84
88		-	-	-	-	-	-	-	-	-	-	-	3.6	88
1)		40.1	30.6	23.4	19.8	17.4	13.2	10.1	8.6	6.8	5.5	4.0	2.6	1)

☰ 6,400 lb		🏗️ 20.3 ft x 21.0 ft					🏗️ 35,5°		360°			85%		
🏗️	🏗️	25.6	33.1	40.7	44.6	48.6	(ft)		71.5	79.4	86.9	94.5	102.4	🏗️
ft		1,000 lb											ft	
10		48.2	51.0	51.8	52.0	35.3	35.3	-	-	-	-	-	-	10
12		47.0	49.7	51.2	50.9	35.3	35.3	35.3	-	-	-	-	-	12
14		45.5	48.4	50.4	48.1	35.3	35.3	35.3	-	-	-	-	-	14
16		41.9	47.3	49.2	45.1	35.3	35.3	35.3	35.3	-	-	-	-	16
18		-	45.5	46.2	42.2	35.3	35.3	35.3	35.3	-	-	-	-	18
20		-	43.0	42.5	39.3	35.3	35.3	35.3	35.2	34.4	-	-	-	20
24		-	34.3	34.2	34.4	34.5	34.5	34.3	33.3	31.5	29.4	-	-	24
28		-	-	28.7	29.2	29.7	29.7	29.0	28.6	27.7	26.5	24.7	19.5	28
32		-	-	22.5	23.1	23.6	23.6	23.6	23.6	23.2	22.5	21.9	17.9	32
36		-	-	-	-	19.5	19.5	19.5	20.1	19.9	19.5	18.6	16.6	36
40		-	-	-	-	-	16.2	16.2	16.6	16.6	15.9	15.5	15.3	40
44		-	-	-	-	-	13.7	13.7	14.2	14.2	13.5	13.3	13.1	44
48		-	-	-	-	-	-	11.7	12.2	12.2	11.8	11.5	11.1	48
52		-	-	-	-	-	-	9.9	10.6	10.6	10.3	9.9	9.5	52
56		-	-	-	-	-	-	-	9.2	9.2	9.2	8.7	8.3	56
60		-	-	-	-	-	-	-	-	8.1	8.0	7.5	7.0	60
64		-	-	-	-	-	-	-	-	7.2	7.0	6.5	6.1	64
68		-	-	-	-	-	-	-	-	6.4	6.1	5.7	5.3	68
72		-	-	-	-	-	-	-	-	5.5	5.3	4.9	4.4	72
76		-	-	-	-	-	-	-	-	-	4.8	4.3	3.9	76
80		-	-	-	-	-	-	-	-	-	-	3.8	3.2	80
84		-	-	-	-	-	-	-	-	-	-	3.3	2.8	84
88		-	-	-	-	-	-	-	-	-	-	-	2.3	88
1)		40.1	30.6	20.1	17.0	14.8	11.0	8.4	7.1	5.5	4.2	2.9	1.5	1)

1) Capacities with horizontal boom

5,300 lb		20.3 ft x 21.0 ft						35,5°		360°				85%	
		(ft)													
		25.6	33.1	40.7	44.6	48.6	56.1	64.0	71.5	79.4	86.9	94.5	102.4		
ft		1,000 lb											ft		
10	48.2	51.0	51.8	52.0	35.3	35.3	-	-	-	-	-	-	-	10	
12	47.0	49.7	51.2	50.9	35.3	35.3	35.3	-	-	-	-	-	-	12	
14	45.5	48.4	50.4	48.1	35.3	35.3	35.3	-	-	-	-	-	-	14	
16	41.9	47.3	49.2	45.1	35.3	35.3	35.3	35.3	-	-	-	-	-	16	
18	-	45.3	45.9	42.2	35.3	35.3	35.3	35.3	-	-	-	-	-	18	
20	-	42.5	42.1	39.3	35.3	35.3	35.3	35.2	34.4	-	-	-	-	20	
24	-	33.7	33.9	34.2	34.3	34.3	34.0	32.9	31.3	29.4	-	-	-	24	
28	-	-	27.7	28.5	29.0	29.0	28.1	27.6	27.0	26.0	24.5	19.5	-	28	
32	-	-	21.6	22.2	22.9	22.9	22.9	22.9	22.7	22.1	21.1	17.9	-	32	
36	-	-	-	-	18.8	18.8	18.8	19.5	19.4	18.8	17.9	16.6	-	36	
40	-	-	-	-	-	15.5	15.5	16.2	16.0	15.5	14.9	14.8	-	40	
44	-	-	-	-	-	13.2	13.2	13.7	13.7	13.1	13.1	12.5	-	44	
48	-	-	-	-	-	-	11.3	11.7	11.7	11.5	11.1	10.6	-	48	
52	-	-	-	-	-	-	9.7	10.1	10.1	9.9	9.5	9.0	-	52	
56	-	-	-	-	-	-	-	9.0	8.8	8.8	8.3	7.9	-	56	
60	-	-	-	-	-	-	-	-	7.7	7.7	7.1	6.6	-	60	
64	-	-	-	-	-	-	-	-	6.7	6.7	6.2	5.7	-	64	
68	-	-	-	-	-	-	-	-	5.9	5.9	5.3	4.8	-	68	
72	-	-	-	-	-	-	-	-	5.1	5.1	4.7	4.2	-	72	
76	-	-	-	-	-	-	-	-	-	4.6	3.9	3.5	-	76	
80	-	-	-	-	-	-	-	-	-	-	3.4	2.9	-	80	
84	-	-	-	-	-	-	-	-	-	-	3.0	2.5	-	84	
88	-	-	-	-	-	-	-	-	-	-	-	2.1	-	88	
1)	40.1	30.2	19.4	16.5	14.3	10.6	7.9	6.6	5.1	4.0	2.6	1.3	1)		

0 lb		20.3 ft x 21.0 ft						35,5°		360°				85%	
		(ft)													
		25.6	33.1	40.7	44.6	48.6	56.1	64.0	71.5	79.4	86.9	94.5	102.4		
ft		1,000 lb											ft		
10	48.2	51.0	51.8	52.0	35.3	35.3	-	-	-	-	-	-	-	10	
12	47.0	49.7	51.2	50.9	35.3	35.3	35.3	-	-	-	-	-	-	12	
14	45.5	48.4	50.4	48.1	35.3	35.3	35.3	-	-	-	-	-	-	14	
16	41.9	47.3	49.2	45.1	35.3	35.3	35.3	35.3	-	-	-	-	-	16	
18	-	44.3	44.9	42.2	35.3	35.3	35.3	35.3	-	-	-	-	-	18	
20	-	40.3	39.6	38.8	35.3	35.2	35.0	34.9	34.1	-	-	-	-	20	
24	-	30.9	31.3	32.1	32.8	32.2	30.7	29.4	28.1	27.3	-	-	-	24	
28	-	-	23.2	23.9	24.5	24.5	24.4	24.1	23.2	22.5	21.1	19.5	-	28	
32	-	-	17.9	18.6	19.1	19.1	19.1	19.7	19.6	18.4	17.5	16.7	-	32	
36	-	-	-	-	15.7	15.7	15.5	16.2	16.2	15.3	15.1	14.2	-	36	
40	-	-	-	-	-	12.7	12.7	13.2	13.1	13.1	12.5	11.8	-	40	
44	-	-	-	-	-	10.6	10.6	11.2	11.1	11.1	10.5	9.9	-	44	
48	-	-	-	-	-	-	9.0	9.4	9.4	9.3	8.8	8.3	-	48	
52	-	-	-	-	-	-	7.5	8.1	8.1	7.9	7.4	7.0	-	52	
56	-	-	-	-	-	-	-	7.0	7.0	6.8	6.3	5.9	-	56	
60	-	-	-	-	-	-	-	-	6.0	5.8	5.3	4.9	-	60	
64	-	-	-	-	-	-	-	-	5.2	5.0	4.5	4.1	-	64	
68	-	-	-	-	-	-	-	-	4.4	4.3	3.7	3.3	-	68	
72	-	-	-	-	-	-	-	-	3.8	3.6	3.1	2.7	-	72	
76	-	-	-	-	-	-	-	-	-	3.1	2.6	2.1	-	76	
80	-	-	-	-	-	-	-	-	-	-	2.1	1.7	-	80	
84	-	-	-	-	-	-	-	-	-	-	1.7	-	-	84	
1)	40.1	25.1	15.9	13.2	11.5	8.4	6.0	5.1	3.5	2.6	1.3	-	1)		

1) Capacities with horizontal boom

		11,700 lb		14.4 ft x 21.0 ft		35,5°		360°		85%				
		(ft)												
		25.6	33.1	40.7	44.6	48.6	56.1	64.0	71.5	79.4	86.9	94.5	102.4	
		1,000 lb												
ft	ft													ft
10		48.2	51.0	51.8	52.0	35.3	35.3	-	-	-	-	-	-	10
12		47.0	49.7	51.2	50.9	35.3	35.3	35.3	-	-	-	-	-	12
14		45.5	48.4	50.0	48.1	35.3	35.3	35.3	-	-	-	-	-	14
16		41.9	43.7	43.6	42.1	35.3	35.3	35.3	35.3	-	-	-	-	16
18		-	36.2	35.6	34.9	34.0	34.0	33.6	32.9	-	-	-	-	18
20		-	30.6	30.8	31.4	31.9	31.9	31.1	29.9	28.6	22.3	-	-	20
24		-	22.2	22.5	22.9	23.4	23.4	23.4	24.0	23.5	22.3	20.7	-	24
28		-	-	17.3	17.7	18.2	18.2	18.2	18.6	18.6	18.0	17.6	16.8	28
32		-	-	13.7	14.1	14.5	14.5	14.5	15.0	15.0	14.8	14.3	14.0	32
36		-	-	-	-	12.2	12.2	12.0	12.6	12.4	12.4	12.0	11.5	36
40		-	-	-	-	-	9.9	9.9	10.4	10.3	10.3	9.9	9.5	40
44		-	-	-	-	-	8.5	8.5	8.9	8.8	8.8	8.4	8.1	44
48		-	-	-	-	-	-	7.2	7.6	7.6	7.6	7.2	6.9	48
52		-	-	-	-	-	-	6.3	6.5	6.5	6.5	6.1	5.9	52
56		-	-	-	-	-	-	-	5.9	5.7	5.7	5.2	5.0	56
60		-	-	-	-	-	-	-	-	4.9	4.9	4.5	4.3	60
64		-	-	-	-	-	-	-	-	4.4	4.4	4.0	3.7	64
68		-	-	-	-	-	-	-	-	3.9	3.9	3.4	3.2	68
72		-	-	-	-	-	-	-	-	3.3	3.3	2.9	2.7	72
76		-	-	-	-	-	-	-	-	-	3.0	2.6	2.2	76
80		-	-	-	-	-	-	-	-	-	-	2.3	1.8	80
84		-	-	-	-	-	-	-	-	-	-	1.9	-	84
1)		32.6	18.5	12.1	10.6	9.3	6.8	5.1	4.4	3.3	2.6	1.5	-	1)

		11,700 lb		7.7 ft x 21.0 ft		35,5°		360°		85%				
		(ft)												
		25.6	33.1	40.7	44.6	48.6	56.1	64.0	71.5	79.4	86.9	94.5	102.4	
		1,000 lb												
ft	ft													ft
18		-	16.8	17.0	17.5	17.9	17.9	17.8	17.9	-	-	-	-	18
20		-	14.0	14.2	14.7	15.1	15.1	15.1	15.6	15.3	14.7	-	-	20
24		-	10.3	10.5	11.0	11.4	11.4	11.4	11.8	11.7	11.7	10.9	-	24
28		-	-	8.1	8.5	8.8	8.8	8.8	9.2	9.2	9.2	8.8	8.2	28
32		-	-	6.3	6.7	6.9	6.9	6.9	7.4	7.4	7.4	6.9	6.5	32
36		-	-	-	-	5.8	5.8	5.8	6.2	6.0	6.0	5.8	5.3	36
40		-	-	-	-	-	4.7	4.7	4.9	4.9	4.9	4.5	4.3	40
44		-	-	-	-	-	3.9	3.9	4.1	4.1	4.1	3.7	3.5	44
48		-	-	-	-	-	-	3.1	3.5	3.5	3.3	3.0	2.8	48
52		-	-	-	-	-	-	2.5	2.9	2.7	2.7	2.5	2.1	52
56		-	-	-	-	-	-	-	2.4	2.4	2.4	2.0	-	56
60		-	-	-	-	-	-	-	-	1.9	1.9	-	-	60
64		-	-	-	-	-	-	-	-	1.5	1.4	-	-	64
1)		-	8.6	5.5	4.9	4.2	2.9	2.0	1.5	-	-	-	-	1)

1) Capacities with horizontal boom

☰ 11,700 lb		☰ 20.3 ft x 21.0 ft		🏗️ 7,1°		360°		85%						
🏗️	🏗️	25.6	33.1	40.7	44.6	48.6	56.1	64.0	71.5	79.4	86.9	94.5	102.4	🏗️
ft		(ft)												ft
		1,000 lb												
14	57.1	-	-	-	-	-	-	-	-	-	-	-	-	14
16	57.1	-	-	-	-	-	-	-	-	-	-	-	-	16
20	-	44.9	-	-	-	-	-	-	-	-	-	-	-	20
24	-	36.2	35.7	-	-	-	-	-	-	-	-	-	-	24
28	-	-	31.2	31.6	-	-	-	-	-	-	-	-	-	28
32	-	-	25.9	26.4	27.0	-	-	-	-	-	-	-	-	32
36	-	-	-	21.7	22.4	22.2	-	-	-	-	-	-	-	36
40	-	-	-	-	-	18.7	18.7	-	-	-	-	-	-	40
44	-	-	-	-	-	15.9	15.9	-	-	-	-	-	-	44
48	-	-	-	-	-	13.8	13.8	14.3	-	-	-	-	-	48
52	-	-	-	-	-	-	12.1	12.5	12.4	-	-	-	-	52
56	-	-	-	-	-	-	-	11.2	10.9	10.5	-	-	-	56
60	-	-	-	-	-	-	-	9.9	9.7	9.5	9.2	-	-	60
64	-	-	-	-	-	-	-	-	8.7	8.6	8.2	-	-	64
68	-	-	-	-	-	-	-	-	7.7	7.7	7.2	6.6	-	68
72	-	-	-	-	-	-	-	-	7.1	6.9	6.4	5.8	-	72
76	-	-	-	-	-	-	-	-	-	6.1	5.6	5.2	-	76
80	-	-	-	-	-	-	-	-	-	-	4.9	4.5	-	80
84	-	-	-	-	-	-	-	-	-	-	4.4	3.9	-	84
88	-	-	-	-	-	-	-	-	-	-	-	3.4	-	88
92	-	-	-	-	-	-	-	-	-	-	-	3.1	-	92
1)	40.1	30.6	22.9	19.6	17.2	13.0	9.9	8.6	6.8	5.5	4.0	2.6	1)	

☰ 6,400 lb		☰ 20.3 ft x 21.0 ft		🏗️ 7,1°		360°		85%						
🏗️	🏗️	25.6	33.1	40.7	44.6	48.6	56.1	64.0	71.5	79.4	86.9	94.5	102.4	🏗️
ft		(ft)												ft
		1,000 lb												
14	57.1	-	-	-	-	-	-	-	-	-	-	-	-	14
16	55.3	-	-	-	-	-	-	-	-	-	-	-	-	16
20	-	42.7	-	-	-	-	-	-	-	-	-	-	-	20
24	-	34.2	34.2	-	-	-	-	-	-	-	-	-	-	24
28	-	-	28.5	29.1	-	-	-	-	-	-	-	-	-	28
32	-	-	22.4	22.9	23.6	-	-	-	-	-	-	-	-	32
36	-	-	-	18.6	19.1	19.0	-	-	-	-	-	-	-	36
40	-	-	-	-	-	15.9	15.9	-	-	-	-	-	-	40
44	-	-	-	-	-	13.6	13.4	-	-	-	-	-	-	44
48	-	-	-	-	-	11.6	11.5	12.0	-	-	-	-	-	48
52	-	-	-	-	-	-	9.9	10.5	10.3	-	-	-	-	52
56	-	-	-	-	-	-	-	9.2	9.2	9.0	-	-	-	56
60	-	-	-	-	-	-	-	8.1	8.0	7.9	7.5	-	-	60
64	-	-	-	-	-	-	-	-	7.0	6.9	6.4	-	-	64
68	-	-	-	-	-	-	-	-	6.1	6.1	5.5	5.0	-	68
72	-	-	-	-	-	-	-	-	5.5	5.3	4.9	4.4	-	72
76	-	-	-	-	-	-	-	-	-	4.8	4.3	3.7	-	76
80	-	-	-	-	-	-	-	-	-	-	3.7	3.1	-	80
84	-	-	-	-	-	-	-	-	-	-	3.3	2.7	-	84
88	-	-	-	-	-	-	-	-	-	-	-	2.3	-	88
92	-	-	-	-	-	-	-	-	-	-	-	2.0	-	92
1)	40.1	30.2	19.6	16.8	14.6	10.8	8.2	6.8	5.3	4.2	2.6	1.5	1)	

1) Capacities with horizontal boom

5,300 lb		20.3 ft x 21.0 ft											7,1°		360°		85%	
		(ft)																
		25.6	33.1	40.7	44.6	48.6	56.1	64.0	71.5	79.4	86.9	94.5	102.4					
ft		1,000 lb											ft					
14	57.1	-	-	-	-	-	-	-	-	-	-	-	-	14				
16	54.9	-	-	-	-	-	-	-	-	-	-	-	-	16				
20	-	42.3	-	-	-	-	-	-	-	-	-	-	-	20				
24	-	33.8	33.9	-	-	-	-	-	-	-	-	-	-	24				
28	-	-	27.7	28.2	-	-	-	-	-	-	-	-	-	28				
32	-	-	21.6	22.2	22.7	-	-	-	-	-	-	-	-	32				
36	-	-	-	17.9	18.6	18.4	-	-	-	-	-	-	-	36				
40	-	-	-	-	-	15.5	15.3	-	-	-	-	-	-	40				
44	-	-	-	-	-	13.0	12.9	-	-	-	-	-	-	44				
48	-	-	-	-	-	11.2	11.1	11.6	-	-	-	-	-	48				
52	-	-	-	-	-	-	9.6	10.1	9.9	-	-	-	-	52				
56	-	-	-	-	-	-	-	8.8	8.8	8.5	-	-	-	56				
60	-	-	-	-	-	-	-	7.7	7.7	7.5	7.0	-	-	60				
64	-	-	-	-	-	-	-	-	6.7	6.6	6.1	-	-	64				
68	-	-	-	-	-	-	-	-	5.9	5.7	5.3	4.8	-	68				
72	-	-	-	-	-	-	-	-	5.3	5.1	4.7	4.0	-	72				
76	-	-	-	-	-	-	-	-	-	4.6	3.9	3.5	-	76				
80	-	-	-	-	-	-	-	-	-	-	3.4	2.9	-	80				
84	-	-	-	-	-	-	-	-	-	-	3.0	2.4	-	84				
88	-	-	-	-	-	-	-	-	-	-	-	2.0	-	88				
92	-	-	-	-	-	-	-	-	-	-	-	1.8	-	92				
1)	40.1	29.1	19.0	16.1	13.9	10.4	7.9	6.6	5.1	4.0	2.4	1.3	1)					







0 lb		20.3 ft x 21.0 ft											7,1°		360°		85%	
		(ft)																
		25.6	33.1	40.7	44.6	48.6	56.1	64.0	71.5	79.4	86.9	94.5	102.4					
ft		1,000 lb											ft					
14	57.1	-	-	-	-	-	-	-	-	-	-	-	-	14				
16	52.9	-	-	-	-	-	-	-	-	-	-	-	-	16				
20	-	40.1	-	-	-	-	-	-	-	-	-	-	-	20				
24	-	30.9	31.1	-	-	-	-	-	-	-	-	-	-	24				
28	-	-	23.1	23.7	-	-	-	-	-	-	-	-	-	28				
32	-	-	17.9	18.4	19.0	-	-	-	-	-	-	-	-	32				
36	-	-	-	14.6	15.3	15.1	-	-	-	-	-	-	-	36				
40	-	-	-	-	-	12.4	12.4	-	-	-	-	-	-	40				
44	-	-	-	-	-	10.5	10.5	-	-	-	-	-	-	44				
48	-	-	-	-	-	8.9	8.9	9.3	-	-	-	-	-	48				
52	-	-	-	-	-	-	7.4	8.1	7.9	-	-	-	-	52				
56	-	-	-	-	-	-	-	7.0	6.8	6.8	-	-	-	56				
60	-	-	-	-	-	-	-	6.0	5.8	5.8	5.1	-	-	60				
64	-	-	-	-	-	-	-	-	5.1	5.0	4.4	-	-	64				
68	-	-	-	-	-	-	-	-	4.4	4.1	3.7	3.2	-	68				
72	-	-	-	-	-	-	-	-	3.8	3.6	3.1	2.7	-	72				
76	-	-	-	-	-	-	-	-	-	3.1	2.6	2.1	-	76				
80	-	-	-	-	-	-	-	-	-	-	2.1	1.6	-	80				
84	-	-	-	-	-	-	-	-	-	-	1.7	-	-	84				
1)	40.1	24.5	15.4	13.0	11.2	8.2	6.0	4.9	3.5	2.6	1.3	-	1)					







1) Capacities with horizontal boom

11,700 lb		14.4 ft x 21.0 ft		7,1°		360°		85%						
		(ft)												
		25.6	33.1	40.7	44.6	48.6	56.1	64.0	71.5	79.4	86.9	94.5	102.4	
ft	1,000 lb													ft
14	55.3	-	-	-	-	-	-	-	-	-	-	-	-	14
16	46.0	-	-	-	-	-	-	-	-	-	-	-	-	16
20	-	30.4	-	-	-	-	-	-	-	-	-	-	-	20
24	-	22.1	22.3	-	-	-	-	-	-	-	-	-	-	24
28	-	-	17.1	17.5	-	-	-	-	-	-	-	-	-	28
32	-	-	13.6	14.0	14.5	-	-	-	-	-	-	-	-	32
36	-	-	-	11.5	11.7	11.7	-	-	-	-	-	-	-	36
40	-	-	-	-	-	9.9	9.9	-	-	-	-	-	-	40
44	-	-	-	-	-	8.4	8.4	-	-	-	-	-	-	44
48	-	-	-	-	-	7.2	7.2	7.6	-	-	-	-	-	48
52	-	-	-	-	-	-	6.3	6.5	6.5	-	-	-	-	52
56	-	-	-	-	-	-	-	5.7	5.7	5.7	-	-	-	56
60	-	-	-	-	-	-	-	5.1	4.9	4.9	4.5	-	-	60
64	-	-	-	-	-	-	-	-	4.4	4.3	4.0	-	-	64
68	-	-	-	-	-	-	-	-	3.9	3.8	3.4	3.1	-	68
72	-	-	-	-	-	-	-	-	3.3	3.3	2.9	2.7	-	72
76	-	-	-	-	-	-	-	-	-	3.0	2.6	2.2	-	76
80	-	-	-	-	-	-	-	-	-	-	2.3	1.8	-	80
84	-	-	-	-	-	-	-	-	-	-	1.9	-	-	84
1)	31.7	18.1	11.9	10.4	9.0	6.8	5.1	4.2	3.3	2.6	1.5	-	-	1)

11,700 lb		7.7 ft x 21.0 ft		7,1°		360°		85%						
		(ft)												
		25.6	33.1	40.7	44.6	48.6	56.1	64.0	71.5	79.4	86.9	94.5	102.4	
ft	1,000 lb													ft
20	-	13.8	-	-	-	-	-	-	-	-	-	-	-	20
24	-	10.3	10.5	-	-	-	-	-	-	-	-	-	-	24
28	-	-	8.0	8.4	-	-	-	-	-	-	-	-	-	28
32	-	-	6.3	6.7	6.9	-	-	-	-	-	-	-	-	32
36	-	-	-	5.3	5.5	5.5	-	-	-	-	-	-	-	36
40	-	-	-	-	-	4.5	4.5	-	-	-	-	-	-	40
44	-	-	-	-	-	3.8	3.7	-	-	-	-	-	-	44
48	-	-	-	-	-	3.1	3.0	3.5	-	-	-	-	-	48
52	-	-	-	-	-	-	2.5	2.9	2.7	-	-	-	-	52
56	-	-	-	-	-	-	-	2.4	2.4	2.2	-	-	-	56
60	-	-	-	-	-	-	-	1.9	1.9	1.9	-	-	-	60
64	-	-	-	-	-	-	-	-	1.5	-	-	-	-	64
1)	-	8.4	5.5	4.6	4.2	2.9	2.0	1.5	-	-	-	-	-	1)

1) Capacities with horizontal boom

 11,700 lb		 20.3 ft x 21.0 ft		 -10,8°		360°		85%						
 	25.6	33.1	40.7	44.6	48.6	(ft)		71.5	79.4	86.9	94.5	102.4		
ft	1,000 lb												ft	
24	-	36.2	-	-	-	-	-	-	-	-	-	-	-	24
32	-	-	25.9	-	-	-	-	-	-	-	-	-	-	32
48	-	-	-	-	-	13.8	-	-	-	-	-	-	-	48
60	-	-	-	-	-	-	-	9.9	-	-	-	-	-	60
68	-	-	-	-	-	-	-	-	7.7	-	-	-	-	68
72	-	-	-	-	-	-	-	-	7.1	-	-	-	-	72
76	-	-	-	-	-	-	-	-	-	6.1	-	-	-	76
80	-	-	-	-	-	-	-	-	-	-	4.9	-	-	80
84	-	-	-	-	-	-	-	-	-	-	-	4.4	-	84
88	-	-	-	-	-	-	-	-	-	-	-	-	3.4	88
92	-	-	-	-	-	-	-	-	-	-	-	-	3.1	92
1)	-	30.6	22.9	-	-	13.0	-	8.6	6.8	5.5	4.0	2.6	1)	

 6,400 lb		 20.3 ft x 21.0 ft		 -10,8°		360°		85%						
 	25.6	33.1	40.7	44.6	48.6	(ft)		71.5	79.4	86.9	94.5	102.4		
ft	1,000 lb												ft	
24	-	34.1	-	-	-	-	-	-	-	-	-	-	-	24
32	-	-	22.2	-	-	-	-	-	-	-	-	-	-	32
48	-	-	-	-	-	11.6	-	-	-	-	-	-	-	48
60	-	-	-	-	-	-	-	8.1	-	-	-	-	-	60
68	-	-	-	-	-	-	-	-	6.1	-	-	-	-	68
72	-	-	-	-	-	-	-	-	5.5	-	-	-	-	72
76	-	-	-	-	-	-	-	-	-	4.8	-	-	-	76
80	-	-	-	-	-	-	-	-	-	-	3.6	-	-	80
84	-	-	-	-	-	-	-	-	-	-	-	3.2	-	84
88	-	-	-	-	-	-	-	-	-	-	-	-	2.2	88
92	-	-	-	-	-	-	-	-	-	-	-	-	2.0	92
1)	-	30.2	19.6	-	-	10.8	-	6.8	5.3	4.2	2.6	1.5	1)	

1) Capacities with horizontal boom

5,300 lb		20.3 ft x 21.0 ft										-10,8°		360°		85%	
		(ft)															
		25.6	33.1	40.7	44.6	48.6	56.1	64.0	71.5	79.4	86.9	94.5	102.4				
ft		1,000 lb										ft					
24	-	33.7	-	-	-	-	-	-	-	-	-	-	-	24			
32	-	-	21.5	-	-	-	-	-	-	-	-	-	-	32			
48	-	-	-	-	-	11.1	-	-	-	-	-	-	-	48			
60	-	-	-	-	-	-	-	7.7	-	-	-	-	-	60			
68	-	-	-	-	-	-	-	-	5.9	-	-	-	-	68			
72	-	-	-	-	-	-	-	-	5.1	-	-	-	-	72			
76	-	-	-	-	-	-	-	-	-	4.6	-	-	-	76			
80	-	-	-	-	-	-	-	-	-	-	3.4	-	-	80			
84	-	-	-	-	-	-	-	-	-	-	3.0	-	-	84			
88	-	-	-	-	-	-	-	-	-	-	-	2.0	-	88			
92	-	-	-	-	-	-	-	-	-	-	-	1.7	-	92			
1)	-	29.1	19.0	-	-	10.4	-	6.6	5.1	4.0	2.4	1.3	-	1)			

0 lb		20.3 ft x 21.0 ft										-10,8°		360°		85%	
		(ft)															
		25.6	33.1	40.7	44.6	48.6	56.1	64.0	71.5	79.4	86.9	94.5	102.4				
ft		1,000 lb										ft					
24	-	30.7	-	-	-	-	-	-	-	-	-	-	-	24			
32	-	-	17.7	-	-	-	-	-	-	-	-	-	-	32			
48	-	-	-	-	-	8.9	-	-	-	-	-	-	-	48			
60	-	-	-	-	-	-	-	6.0	-	-	-	-	-	60			
68	-	-	-	-	-	-	-	-	4.3	-	-	-	-	68			
72	-	-	-	-	-	-	-	-	3.8	-	-	-	-	72			
76	-	-	-	-	-	-	-	-	-	3.1	-	-	-	76			
80	-	-	-	-	-	-	-	-	-	-	2.0	-	-	80			
84	-	-	-	-	-	-	-	-	-	-	1.6	-	-	84			
1)	-	24.5	15.4	-	-	8.2	-	4.9	3.5	2.6	1.3	-	-	1)			

11,700 lb		14.4 ft x 21.0 ft										-10,8°		360°		85%	
		(ft)															
		25.6	33.1	40.7	44.6	48.6	56.1	64.0	71.5	79.4	86.9	94.5	102.4				
ft		1,000 lb										ft					
24	-	22.1	-	-	-	-	-	-	-	-	-	-	-	24			
32	-	-	13.6	-	-	-	-	-	-	-	-	-	-	32			
48	-	-	-	-	-	7.2	-	-	-	-	-	-	-	48			
60	-	-	-	-	-	-	-	4.9	-	-	-	-	-	60			
68	-	-	-	-	-	-	-	-	3.9	-	-	-	-	68			
72	-	-	-	-	-	-	-	-	3.3	-	-	-	-	72			
76	-	-	-	-	-	-	-	-	-	2.8	-	-	-	76			
80	-	-	-	-	-	-	-	-	-	-	2.1	-	-	80			
84	-	-	-	-	-	-	-	-	-	-	1.9	-	-	84			
1)	-	18.1	11.9	-	-	6.6	-	4.2	3.3	2.6	1.5	-	-	1)			

11,700 lb		7.7 ft x 21.0 ft										-10,8°		360°		85%	
		(ft)															
		25.6	33.1	40.7	44.6	48.6	56.1	64.0	71.5	79.4	86.9	94.5	102.4				
ft		1,000 lb										ft					
24	-	10.2	-	-	-	-	-	-	-	-	-	-	-	24			
32	-	-	6.3	-	-	-	-	-	-	-	-	-	-	32			
48	-	-	-	-	-	3.0	-	-	-	-	-	-	-	48			
60	-	-	-	-	-	-	-	1.9	-	-	-	-	-	60			
1)	-	8.4	5.5	-	-	2.9	-	1.5	-	-	-	-	-	1)			

1) Capacities with horizontal boom

11,700 lb 0°* 35,5° 85%						
ft	25.6 ft	33.1 ft	40.7 ft	44.6 ft	1,000 lb	
					10	48.2
12	44.5	41.3	36.6	34.6		
14	34.5	32.9	29.9	28.5		
16	26.7	25.8	24.8	23.8		
18	-	21.1	20.6	20.0		
20	-	17.2	16.8	16.6		
24	-	12.5	11.9	11.9		
28	-	-	8.9	8.7		
32	-	-	6.6	6.6		
1)	19.4	10.1	5.7	4.2		

11,700 lb 0°* 7,1° 85%						
ft	25.6 ft	33.1 ft	40.7 ft	44.6 ft	1,000 lb	
					14	34.1
16	26.7	-	-	-		
20	-	17.0	-	-		
24	-	12.3	11.7	-		
28	-	-	8.7	8.6		
32	-	-	6.6	6.6		
36	-	-	-	4.9		
1)	19.0	9.9	5.5	4.2		

11,700 lb 0°* -10,8° 85%						
ft	25.6 ft	33.1 ft	40.7 ft	44.6 ft	1,000 lb	
					24	-
32	-	-	6.6	-		
1)	-	9.9	5.5	-		

11,700 lb 180°** 35,5° 85%						
ft	25.6 ft	33.1 ft	40.7 ft	44.6 ft	1,000 lb	
					10	27.0
12	23.2	22.7	22.3	22.1		
14	20.2	19.5	19.2	19.1		
16	17.7	17.0	16.7	16.6		
18	-	15.0	14.8	14.6		
20	-	13.2	13.0	12.8		
24	-	10.4	10.2	10.0		
28	-	-	8.0	7.8		
32	-	-	6.3	6.1		
1)	14.3	8.8	5.5	4.2		

11,700 lb 180°** 7,1° 85%						
ft	25.6 ft	33.1 ft	40.7 ft	44.6 ft	1,000 lb	
					14	20.0
16	17.5	-	-	-		
20	-	13.0	-	-		
24	-	10.4	10.0	-		
28	-	-	7.9	7.8		
32	-	-	6.3	6.1		
36	-	-	-	4.7		
1)	14.1	8.6	5.3	4.0		

11,700 lb 180°** -10,8° 85%						
ft	25.6 ft	33.1 ft	40.7 ft	44.6 ft	1,000 lb	
					24	-
32	-	-	6.1	-		
1)	-	8.6	5.3	-		

1) Capacities with horizontal boom

* over rear

** over front

11,700 lb 360° 35,5° 85%				
ft	25.6 ft	33.1 ft	40.7 ft	44.6 ft
1,000 lb				
16	-	13.0	12.6	12.3
18	-	11.2	10.7	10.5
20	-	9.5	9.0	8.8
24	-	6.9	6.5	6.3
28	-	-	4.6	4.6
32	-	-	3.1	3.1
1)	-	5.5	2.4	1.5

11,700 lb 360° 7,1° 85%				
ft	25.6 ft	33.1 ft	40.7 ft	44.6 ft
1,000 lb				
16	13.4	-	-	-
20	-	9.3	-	-
24	-	6.8	6.3	-
28	-	-	4.6	4.4
32	-	-	3.1	2.9
36	-	-	-	2.0
1)	10.4	5.3	2.4	1.3

11,700 lb 360° -10,8° 85%				
ft	25.6 ft	33.1 ft	40.7 ft	44.6 ft
1,000 lb				
24	-	6.7	-	-
32	-	-	3.1	-
1)	-	5.3	2.4	-

1) Capacities with horizontal boom

Notes to Lifting Capacity

Ratings are in compliance with ASME B30.5.
Lifting capacities do not exceed 85 % of tipping load.

Consult operation manual for further details.

Note: Data published herein is intended as a guide only and shall not be construed to warrant applicability for lifting purposes. Crane operation is subject to the computer charts and operation manual both supplied with the crane.

Runner and cross bar

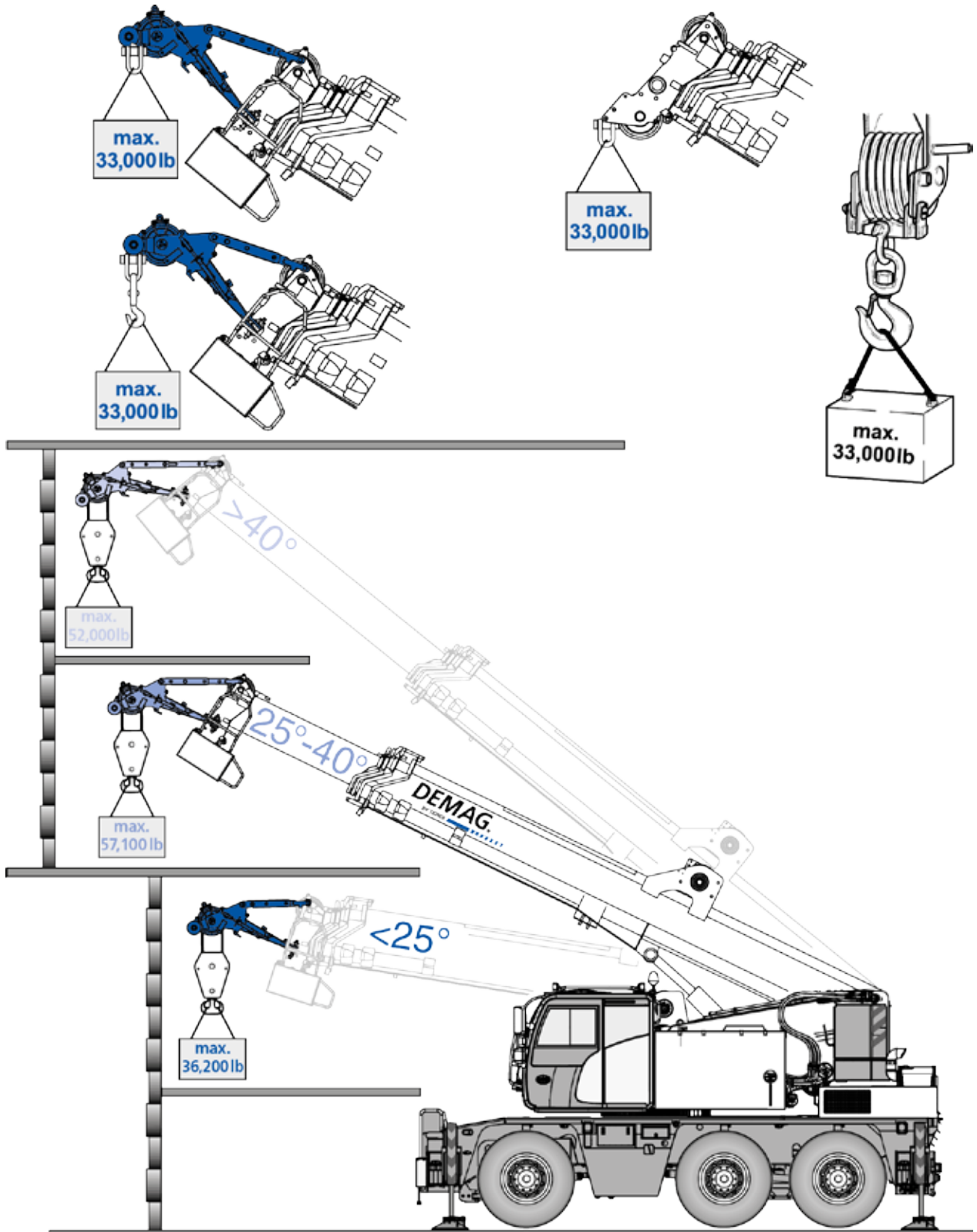

Basic machine

Equipment carrier

Engine 260-4	MTU 6R1000; Diesel engine; 260 kW / 2200 1/min (348 HP), torque 1400 Nm / 1200-1600 1/min; The engine complies with Euromot 4 / Tier 4F; Exhaust system complete stainless steel with SCR catalyzer.
Fuel tank	Fuel tank 79 gallons Diesel (no RME / biodiesel); 11 gallons AdBlue tank.
Transmission Allison	Allison automated gearbox with torque converter, 6 forward speeds and 1 reverse; 2-stage transfer case with switchable off-road gear and switchable longitudinal lock.
Axles 6 x 4 x 6	6 x 4 x 6; 3 axles, axles 1 and 3 are driven and equipped with selectable transverse lock; All axles steered.
Suspension	Hydropneumatic suspension with axle load compensation; Hydraulically lockable; Manual or automatic levelling alternatively.
Steering	Dual circuit hydro semiblock steering with emergency steering pump; Active rear axle steering.
Brakes	Pneumatic dual circuit service brake with antilock system, acting on all wheels; Disk brakes; Additional exhaust brake and constant throttle valve; Spring-loaded parking brake.
Tire size 445/65 R22.5 (18.00 R22.5)	Tire size 445/65 R22.5 (18.00 R22.5); Steel rim 14-22.5.
Drive lights	Including low beam, upper beam, daytime running lights.
Outriggers	H-4-Point design; Vertical and horizontal movement fully hydraulic; Manual or automatic levelling alternatively; 3 outrigger bases of 7.7 ft, 14.4 ft and 20.3 ft.
Outrigger pads 020 PA	4 round outrigger pads A = 0.66 ft ² with transport position at vertical cylinder; Polyamide.
Pneumatic tire filling plug	Pneumatic tire filling plug for self-filling of the wheels.
Contour safety marking	Continuous reflective strips on the sides of the chassis and in the back.

Equipment superstructure

Telescopic boom HA31	25.6 ft - 102.4 ft; Fully hydraulic telescoping system; Attachments for all equipment and extensions; 4 sheaves integrated in boom head for max. capacity of 75,300 lb.
Boom luffing	Single luffing cylinder with automatic lowering brake valve.
Rotary drive	Single slewing gear unit with spring-loaded multi-disc brake.
H1	Hoist with spring-loaded multi-disc brake; Resolver (hoist rotation indicator).
Counterweight 11,700 lb	11,700 lb, 3 pieces.
Control system	Enabling 4 simultaneous working movements; Electric pilot controls via 2 two-axis joysticks; Different control modes selectable for hydraulic circuits.
Operator aids	IC-1, with Integrated load moment indicator acc. EN13000; Color display; Displaying of current operating conditions, load charts, fault indicator; Signal lights indicating LMI-load; Crane data logger.
Outrigger basis monitoring	Surveillance of each outrigger beam for detection of horizontal stroke; Warning in case of anomaly in crane cabin (Attention: There is no automatic linkage with the LMI-system).
Outrigger load indicator	The outrigger load is indicated in the crane cabin and the outrigger control box.
Hook height indication	Displaying and programmability of the hook height H1 by IC-1.
Cab 875	Type 2.87 ft; Steering wheel height and tilt adjustable; Seat heating; Tinted glass; Power mirrors with heater; Handrails; Pull-down sun visor and light curtains; Radio-preparation.
Heating engine-independent	Engine-independent warm water heating with 5 kW heating power; With timer.
Tachograph	Display of the speed and record according to country-specific regulations.
Electronic immobilizer system	Prevents uncontrolled carrier mobilization; Incl. 5 ignition keys.
Anemometer	Disconnectable and usable in HA and HAV configuration.

Additional equipment

Carrier

Axles 6 x 6 x 6	6 x 6 x 6; Axles 1 and 3 permanently driven; Axle 2 connectable with longitudinal lock; All 3 axles equipped with shiftable transverse lock; All 3 axles steered.
CombiBox tail	Storage box for crane equipment at carrier tail.
Hook storage	Storage for single line hook (5-0-16) at carrier front.
Timber storage front	Storage for 20 x squared timber 10 x 10 x 3.3 ft at carrier front incl. lashing for secure stowage.

Superstructure

Counterweight storage	Counterweight jack-up cylinder for disassembly of 5,300 lb counterweight plate (c) without assist crane.
Rope anchor point	Additional rope anchor point at boom head front, enabling to reach maximum possible hook heights; approx. 1.3 ft increase in lifting height possible.
Additional sheave on main boom head	1 additional sheave; For total 5 sheaves at boom head; Max. capacity of 88,200 lb.
2. hoist (H2)	2. hoist; Spring-loaded multi-disc brake; Resolver (hoist rotation indicator); Incl. quick couplings; Displaying and programmability of the hook height H2 by IC-1.
Aircondition	Aircondition with 7 kW rated cooling capacity.

Handling

Remote control	Control of superstructure operations via wireless remote control.
Working range limiter	Displaying and programmability of the work range limits by IC-1.
IC-1 Plus	Smart crane control system for main boom and runner configuration enabling higher lifting capacities especially over outriggers. Enables safe use of the full capacity of the crane even in asymmetric outrigger configurations. Outriggers can be positioned independently and infinitely. Capacity precalculation for +/- 30° slewing angle and radius area. In-cab lift simulation.

Extensions

HAV 23.0 ft	23.3 ft; Swing-away jib, manual offset 30°; 1-sheaved head; Incl. transport storage.
HAV 42.7 ft	42.7 ft; Double folding swing-away jib, manual offset 30°; 1-sheaved head; Incl. transport storage; Includes HAV 23.0 ft.
MS (runner)	4.3 ft; Variable assembly jib (runner) with manual offset; 3 sheaves; Max. capacity 57,100 lb; Incl. bridle traverse and ramshorn hook.
Boom head traverse complete	Searcher hook for main boom head; Incl. shackle and hook.

Hook Blocks

Hook block 50-5-16-D	50-5-16-D (904 lb); Hook block with ramshorn hook; With white red signal stripes.
Hook block 32-3-16-D	32-3-16-D (772 lb); Hook block with ramshorn hook; With white red signal stripes.
Hook block 16-1-16-E	16-1-16-E (496 lb); Hook block with single hook; With white red signal stripes.
Hook 5-0-16-E	5-0-16-E (287 lb); Single hook; Red.

Further additional equipment on request!

Weight data may deviate from posted values based on road / travel configuration, equipment configuration, and component weight tolerances.

December 2017. Product specifications and prices are subject to change without notice or obligation. The photographs and/or drawings in this document are for illustrative purposes only. Refer to the appropriate Operator's Manual for instructions on the proper use of this equipment. Failure to follow the corresponding Operator's Manual when using our equipment or to otherwise act responsibly may result in serious injury or death. The only warranty applicable to our equipment is the standard written warranty applicable to the particular product and sale and Terex makes no other warranty, express or implied. Products and services listed may be trademarks, service marks or trade-names of Terex Corporation and/or its subsidiaries in the USA and other countries. All rights are reserved. Terex, Demag and Above, Ahead, Always are trademarks of or licensed by Terex Corporation or its subsidiaries.

© Terex Cranes 2017

TEREX CRANES GERMANY GMBH

Dinglerstraße 24
66482 Zweibrücken
Germany

E info.cranes@terex.com
T +49 6332 830

www.terex.com/cranes
linkedin.com/company/demagmobilecranes
facebook.com/TerexCranes
youtube.com/TerexCranesMarketing

DEMAG[®]
BY TEREX 